



User Guide

Quality, Design and Innovation



















home.liebherr.com/fridge-manuals







LIEBHERR



Contents

1	Appliance at a glance.....	3
1.1	Scope of delivery.....	3
1.2	Overview of the appliance and equipment.....	3
1.3	SmartDevice.....	3
1.4	Appliance range of use.....	3
1.5	Conformity.....	4
2	General safety instructions.....	4
3	Putting into operation.....	6
3.1	Switching on appliance.....	6
3.2	Inserting the components.....	6
4	Foods management.....	6
4.1	Storing food.....	6
4.2	Storage times.....	7
5	Saving energy.....	7
6	Controls.....	7
6.1	Controls and displays.....	7
6.1.1	Status display.....	7
6.1.2	Navigation.....	7
6.1.3	Display symbols.....	8
6.2	Control concept.....	8
6.2.1	Activating/deactivating the function.....	8
6.2.2	Selecting function value.....	8
6.2.3	Activating/deactivating settings.....	8
6.2.4	Selecting the setting value.....	8
6.2.5	Go to the Customer menu.....	9
6.3	Functions.....	9
	Turn off appliance.....	9
	WiFi.....	9
	Temperature.....	10
	SuperFrost.....	10
	PartyMode.....	10
	SabbathMode.....	10
	EnergySaver.....	11
	IceMaker / MaxIce.....	11
	Ice cubes.....	11
	TubeClean.....	11
	Display brightness.....	11
	Door alarm.....	12
	Entry lock.....	12
	Language.....	12
	Info.....	12
	Reminder.....	12

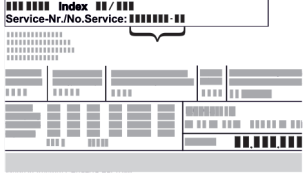
	Reset.....	12
6.4	Fault messages.....	12
6.4.1	Warnings.....	12
6.4.2	Message.....	13
6.4.3	DemoMode.....	13
7	Features.....	13
7.1	Drawers.....	13
7.2	Pull-out board with IceTower.....	14
7.3	Glass shelves.....	16
7.4	IceMaker.....	17
7.5	VarioSpace.....	17
7.6	Accessories.....	17
8	Maintenance.....	17
8.1	Disassembling / assembling pull-out systems.....	17
8.2	Defrosting the appliance.....	20
8.3	Cleaning the appliance.....	20
9	Customer help.....	21
9.1	Technical specifications.....	21
9.2	Operating noises.....	21
9.3	Technical fault.....	21
9.4	Customer Services.....	23
9.5	Model plate.....	23
10	Shutting down.....	23
11	Disposal.....	23
11.1	Preparing appliance for disposal.....	23
11.2	Disposing of the appliance in an environmentally friendly manner.....	23

The manufacturer is continually working on the further development of all types and models. Please be aware that we reserve the right to make changes to the shape, equipment and technology.

Symbol	Explanation
	Read instructions Please read the information in these instructions carefully to understand all of the benefits of your new appliance.
	Full instructions on the internet You can find detailed instructions on the internet using the QR code on the front of these instruction or by entering the service number at home.liebherr.com/fridge-manuals . The service number can be found on the serial tag:  <i>Fig. Example illustration</i>
	Check appliance Check all parts for transport damage. If you have any complaints, please contact your agent or customer service.
	Differences These instructions apply to a range of models, so differences are possible. Sections that apply to certain models only are marked with an asterisk (*).

Symbol	Explanation
	Instructions and results Instructions are marked with a ▶. Results are marked with a ▷.
	Videos Videos about the appliances are available on the YouTube channels of Liebherr-Hausgeräte.

These operating instructions apply to:

SIFNh 51..

1 Appliance at a glance

1.1 Scope of delivery

Check all parts for damage during transport. If you have any complaints, please contact your retailer or Customer Services (see 9.4 Customer Services).

Your new appliance comes with the following parts:

- Built-in appliance
- Features (depending on the model)
- Installation materials (depending on the model)
- User Guide
- Installation Guide

1.2 Overview of the appliance and equipment

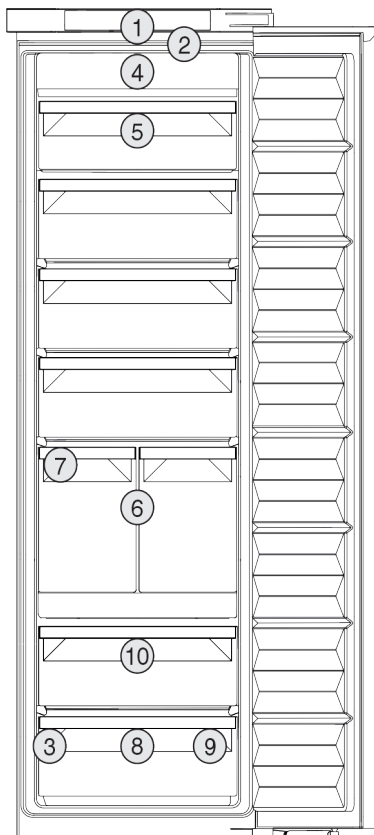

Fig. 1 Example illustration

Equipment

- | | |
|--------------|--------------|
| (1) Controls | (6) IceTower |
| (2) Lighting | (7) IceMaker |

(3) Serial tag

(8) Freezer tray, cold storage accumulator

(4) NoFrost

(9) Ice cube scoop

(5) Tilting drawer

(10) VarioSpace

Note

- ▶ Shelves, drawers and baskets are arranged for optimum energy efficiency when the appliance is delivered. Changing how the shelves, for example, are inserted in the fridge compartment does not have any impact on energy consumption.

1.3 SmartDevice

SmartDevice is the networking solution for your freezer.

If your appliance SmartDevice-enabled or compatible, you can quickly and easily connect your appliance to your WiFi. With the SmartDevice app, you can operate your appliance from a mobile device. Additional functions and setting options are available in the SmartDevice SmartDevice app.

SmartDevice-compatible appliance:

Your appliance is compatible for use with the SmartDeviceBox. You must first purchase and install the SmartDeviceBox. In order to connect your appliance to the WiFi, you need to download the SmartDevice app.



More information about SmartDevice: smartdevice.liebherr.com

Purchasing the SmartDeviceBox in the Liebherr-Hausgeräte store: home.liebherr.com/shop/de/deu/smartdevicebox.html

Downloading the SmartDevice-app:



After installing and configuring the SmartDevice, you can connect your appliance to the WiFi using the SmartDevice app and the WiFi appliance function (see WiFi).

Note

You cannot use the SmartDeviceBox in the following countries: Belarus, Kazakhstan, Russia. The SmartDevice function is not available.

1.4 Appliance range of use

Intended use

The appliance is only suitable for cooling food products in a domestic or household-like environment. This includes, for example, use:

- in staff kitchens, bed and breakfast establishments,

General safety instructions

- by guests in country houses, hotels, motels and other accommodation,
- for catering and similar services in the wholesale trade.

All other types of use are not permitted.

Foreseeable misuse

The following applications are expressly forbidden:

- Storing and refrigerating medicines, blood plasma, laboratory preparations or similar substances and products based on the Medical Device Directive 2007/47/EC
- Use in outdoor areas with very high humidity
- Use in areas at risk of explosions

Misusing the appliance may lead to damage to the goods stored or they may spoil.

Climate classifications

Depending on the climate classification the appliance is designed to operate in restricted ambient temperatures. The climate classification applying to your appliance is printed on the rating plate.

Note

- Keep to the specified ambient temperatures in order to guarantee that the appliance works properly.

Climate classification	for ambient temperatures of
SN	10 °C to 32 °C
N	16 °C to 32 °C
ST	16 °C to 38 °C
T	16 °C to 43 °C
SN-ST	10 °C to 38 °C
SN-T	10 °C to 43 °C

1.5 Conformity

The refrigerant circuit has been tested for leaks. When installed, the appliance complies with the applicable safety regulations and with the corresponding directives.

The full text of the EU Declaration of Conformity is available on the following website: www.Liebherr.com

2 General safety instructions

Please keep these instructions in a safe place and pass them on to any subsequent owners. Read these operating instructions carefully before use to ensure safe and correct use of the appliance. Follow the instructions, safety instructions and warning messages included at all times. They are important for ensuring

you can operate and install the appliance safely and without any problems.

Danger for the user:

- This device can be used by children and people with impaired physical, sensory or mental abilities or with a lack of experience and knowledge provided that they are supervised or have received instruction in the safe use of this device, and about the resulting hazards. Children must not play with this appliance. Cleaning and user maintenance work must not be carried out by children without adult supervision. Children aged between 3 and 8 are allowed to load and unload the appliance. Children below the age of 3 must be kept away from the appliance unless they are under continuous adult supervision.
- The socket must be easily accessible so that the appliance can be disconnected quickly from the electricity in an emergency. It must not be located in the area behind the appliance.
- When disconnecting the appliance from the supply, always take hold of the plug. Do not pull the cable.
- In the event of a fault pull out the mains plug or deactivate the fuse.
- Do not damage the mains power cable. Do not operate the appliance with a defective mains power cable.
- If the supply cord is damaged, it must be replaced by a special cord or assembly available from the manufacturer or its service agent.
- Only customer service or other specially trained staff may repair or perform other operations on the appliance.
- Only install, connect and dispose of the appliance according to the instructions.
- Only use the appliance when is installed.
- Special lights, such as LED lights on the appliance, are used to illuminate the interior of the appliance and are not suitable for room lighting.
- The manufacturer is not liable for damage caused by a faulty fixed water connection.

Fire hazard:

- This appliance contains a refrigerant which is environmentally friendly, but flammable. Leaking refrigerant may ignite. It is hazardous for anyone other than an Authorised Service Person to service this appliance. In Queensland, the authorised Service Person MUST hold a Gas Work

Authorisation for hydrocarbon refrigerants, to carry out Servicing or repairs where the gas system is being opened or charged.

- The coolant used (information on the model plate) is ecofriendly but also flammable. Any leaking coolant may ignite.
 - Do not damage the refrigerant circuit pipes.
 - Do not handle ignition sources inside the appliance.
 - Do not use electrical appliances inside the appliance (e.g. steam cleaners, heaters, ice cream makers, etc.).
 - If the refrigerant leaks: remove any naked flames or ignition sources from the vicinity of the leakage point. Properly air the room. Inform customer services.
- Do not store explosives or sprays using combustible propellants such as butane, propane, pentane, etc. in the appliance. To identify these spray cans, look for the list of contents printed on the can, or a flame symbol. Gases possibly escaping may ignite due to electrical components.
- Keep burning candles, lamps and other items with naked flames away from the appliance so that they do not set the appliance on fire.
- **WARNING:** Keep ventilation openings, in the appliance enclosure or in the built-in structure, clear of obstruction.
- **WARNING:** Do not use mechanical devices or other means to accelerate the defrosting process, other than those recommended by the manufacturer.
- **WARNING:** Do not damage the refrigerant circuit.
- Please be sure to store alcoholic drinks or other packaging containing alcohol in tightly closed containers. Any alcohol that leaks out may be ignited by electrical components.

Danger of tipping and falling:

- Do not misuse the plinth, drawers, doors etc. as a step or for support. This applies particularly to children.
- Danger of tipping if the door is opened before the appliance is properly installed.

Danger of food poisoning:

- Do not consume food which has been stored too long.

Danger of frostbite, numbness and pain:

- Avoid prolonged skin contact with cold surfaces or refrigerated/frozen goods or take protective measures, e.g wear gloves.
- Do not consume ice cream, water ice or ice cubes immediately and do not consume them too cold.

Danger of injury and damage:

- Hot steam can lead to injury. Do not use electrical heating or steam cleaning equipment, open flames or defrosting sprays to defrost.
- Do not use sharp implements to remove the ice.

Risk of crushing:

- Do not hold the hinge when opening and closing the door. Fingers may get caught.

Symbols on the appliance:



This symbol may be located on the compressor. It relates to the oil in the compressor and makes reference to the risk that: Swallowing or inhaling can be fatal. This advice is only relevant to recycling. There is no danger in normal operation.



This symbol is located on the compressor and indicates the danger of flammable materials. Do not remove the sticker.



This or a similar sticker may be located on the rear of the appliance. It refers to the foam-padded panels in the door and/or the housing. This advice is only relevant to recycling. Do not remove the sticker.

Please note the warning messages and other specific advice in the other chapters:

	DANGER	indicates an immediately hazardous situation which will lead to death or serious injuries if it is not avoided.
	WARNING	indicates a hazardous situation which may lead to death or serious injuries if it is not avoided.
	CAUTION	indicates a hazardous situation which may lead to minor or moderate injuries if it is not avoided.
	NOTICE	indicates a hazardous situation which may lead to damage to property if it is not avoided.
	Note	indicates useful instructions and tips.

Putting into operation

3 Putting into operation

3.1 Switching on appliance

Ensure that the following conditions are met:

- Appliance is installed and connected according to installation instructions.
- All adhesive strips, adhesive and protective films as well as transport safety devices in and on the appliance are removed.
- All marketing leaflets are removed from the drawers.

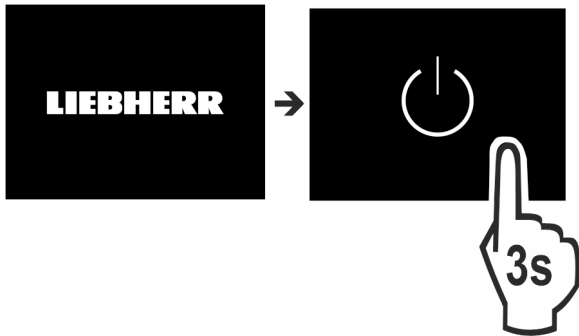

Fig. 2

- ▶ Switch on the appliance using the display.

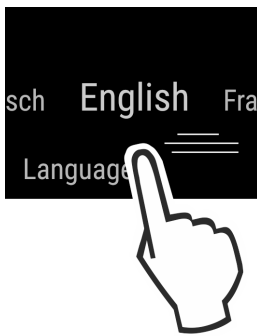

Fig. 3

- ▶ Select the language.
- ▷ The status display appears.

The appliance starts in DemoMode:

If the appliance starts in DemoMode, you can deactivate DemoMode within the next 5 minutes.

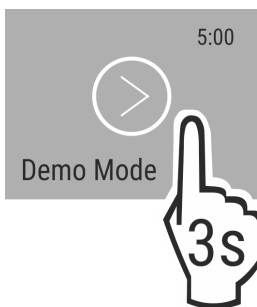

Fig. 4

- ▶ Press DemoMode for 3 seconds.
- ▷ DemoMode is deactivated.

Note

The manufacturer recommends:

- ▶ **Store frozen foods** at -18 °C or colder.

3.2 Inserting the components

- ▶ Insert the supplied components to make the most of your appliance.

Note

You can purchase accessories from the [Liebherr household appliance store](http://home.liebherr.com) (home.liebherr.com).

4 Foods management

4.1 Storing food



WARNING

Risk of fire

- ▶ Do not use any electrical appliances in the food area of the appliance unless recommended by the manufacturer.

Note

The energy consumption increases and the cooling power goes down if ventilation is not sufficient.

- ▶ Always keep air slots clear.

When storing food, always observe the following:

- Air vents on the inside rear wall are unobstructed.
- Air vents on the fan are unobstructed.
- Food is in sealed packaging.
- Raw meat and fish are in clean, sealed containers to prevent them coming into contact with or dripping onto other foods.
- Foods are not stored too closely together, as the air needs to circulate.

Note

Failure to follow these guidelines can lead to food perishing.

4.1.1 Freezer compartment

This provides a dry, frosty storage climate at -18 °C. A frosty climate is great for storing frozen food and frozen goods for several months, making ice cubes and freezing fresh food.

Freezing food

You can freeze as many kilograms of fresh food within 24 hours as indicated on the nameplate (see 9.5 Model plate) under "freezing capacity ... kg/24h".

So that the food is rapidly frozen through to the core, keep to the following quantities per pack:

- Fruit, vegetables up to 1 kg
- Meat up to 2.5 kg

Before freezing goods, please make sure of the following:

- SuperFrost is activated (see 6.3 Functions) when the amount of food to freeze exceeds approx. 2 kg.
- With a small amount of frozen goods: SuperFrost is activated approx. 6 hours prior.
- With the maximum amount of frozen goods: SuperFrost is activated approx. 24 hours prior.

Arrange your food as follows:



CAUTION

Risk of injury from glass fragments!

Drink bottles and cans may explode if frozen. This applies particularly to carbonated drinks.

- ▶ Only freeze drink bottles and cans when using the *bottle timer* function.

For appliances smaller than 122 cm:

With a small amount of frozen goods:

- ▶ Distribute packaged groceries across all drawers.
- ▶ If possible, place groceries at the back of the drawer near the rear wall.

With a maximum amount of frozen goods:

- ▶ Distribute packaged groceries across all drawers.
- ▶ If possible, place groceries at the back of the drawer near the rear wall.

For appliances larger than or exactly 122 cm:

With a small amount of frozen goods:

- ▶ Distribute packaged groceries across all drawers, but do not place any groceries in the top drawer.

With a maximum amount of frozen goods:

- ▶ Distribute packaged groceries across all drawers.
- ▶ If possible, place groceries at the back of the drawer near the rear wall.

For all appliances:

With a maximum amount of frozen goods:

- ▶ Once SuperFrost deactivates automatically, place food into the drawer.

Defrost the food

- In the fridge
- In the microwave
- In the stove/oven
- At room temperature



WARNING

Risk of food poisoning!

- ▶ Do not re-freeze thawed food.

- ▶ Only take out the food you need at the time.
- ▶ Cook defrosted food as soon as possible.

Freezer tray

Use the freezer tray for berries, herbs, vegetables and other small goods without them freezing together in the process. The food keeps its shape and is easier to separate into portions later on.

You can also store the freezer packs in the freezer tray to save space.

- ▶ Spread food, unsealed, at a good distance apart, over the whole surface of the freezer tray.

4.2 Storage times

Refer to the specified storage times as a guide.

In the case of foods with a minimum shelf life, the date indicated on the packaging still applies.

Recommended storage period for various types of food		
Ice cream	at -18 °C	2 to 6 months
Sausages, ham	at -18 °C	2 to 3 months
Bread, baked goods	at -18 °C	2 to 6 months
Game, pork	at -18 °C	6 to 9 months
Fatty fish	at -18 °C	2 to 6 months
Lean fish	at -18 °C	6 to 8 months
Cheese	at -18 °C	2 to 6 months
Poultry, beef	at -18 °C	6 to 12 months
Vegetables, fruit	at -18 °C	6 to 12 months

5 Saving energy

- Pay attention to good ventilation. Do not cover ventilation holes or grids.
- Always keep the fan air slits clear.
- Do not install the appliance in direct sunlight, next to an oven, radiator or similar.
- Energy consumption depends on the installation conditions, e.g. the ambient temperature (see 1.4 Appliance range of use). A warmer ambient temperature can increase the energy consumption.
- Open the appliance for as short a time as possible.
- The lower the temperature is set the higher the energy consumption.
- Keep all food properly packed and covered. This prevents frost from forming.
- Inserting warm food: allow to cool down to room temperature first.

6 Controls

6.1 Controls and displays

The display provides a quick overview of the temperature setting and the status of functions and settings. You can control the functions and settings either by deactivating/activating them or by selecting a value.

6.1.1 Status display

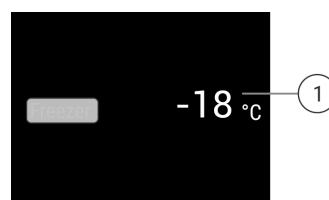

Fig. 5

(1) Temperature display

The Status display shows the set temperatures and is the home display. From there, you can navigate to the options and settings.

6.1.2 Navigation

Navigate in the menu to access the individual functions. An audible signal sounds after confirming a function or setting. If no selection is made after 10 seconds the display switches to the Status display.

The appliance is operated by swiping and confirming in the display:

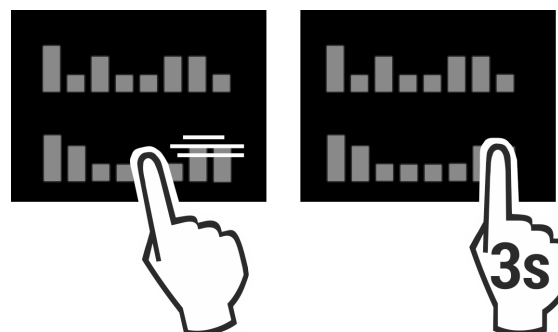



Fig. 6

Controls

Back:





- Confirm your selection in the submenu. The display returns to the menu.
- . The display returns to the function/setting.

Back to Status display:

- Close and open the door.
- Wait 10 seconds. The display switches to the Status display.

6.1.3 Display symbols





Display symbols provide information on the current appliance status:

Symbol	Appliance status
	Standby The appliance or temperature zone is switched off.
	Flashing number Appliance is working. Temperature flashes until the set temperature is reached.
	
	Flashing symbol Appliance is working. Setting is made.
	

6.2 Control concept

6.2.1 Activating/deactivating the function

You can activate/deactivate the following functions:

Symbol	Function
	SuperFrost ^x
	IceMaker and MaxIce ^x
	PartyMode ^x
	EnergySaver

^x When function is on, the appliance works harder. This means appliance noise when operating may be louder for a short while, and more energy will be consumed.

- ▶ Swipe left in the display until the function appears.
- ▶ Confirm selected function with a short tap.
- ▷ You hear the confirmation tone.
- ▷ Status appears in the menu.
- ▷ Function is on/off.

6.2.2 Selecting function value

With the following functions you can set a value in the submenu:

Symbol	Function
	Setting the temperature
	Switch the appliance on/off







- ▶ Swipe left in the display until the function appears.
- ▶ Confirm selected function with a short tap.
- ▶ Select the setting value by swiping the display.

Setting the temperature

- ▶ Confirm with a short tap.
- ▷ You hear the confirmation tone.
- ▷ The display changes to blue when it is activated.
- ▷ Display switches back to the menu.

6.2.3 Activating/deactivating settings

You can activate/deactivate the following settings:

Symbol	Setting
	WiFi ¹
	Entry lock ²
	SabbathMode ²
	Reminders ¹
	Reset ²
	Switch off ²

- ▶ Swipe left in the display until Settings  appears.
- ▶ Tap to confirm settings.
- ▶ Swipe until you see the setting you want.

¹ Activate setting (shortpress)



- ▶ Tap briefly to confirm.
- ▷ You hear the confirmation tone.
- ▷ Status appears in the menu.
- ▷ Setting is on / off.

² Activate setting (longpress)

- ▶ Press the selection for 3 seconds to confirm.
- ▷ You hear the confirmation tone.
- ▷ Status appears in the menu.
- ▷ Display changes.

6.2.4 Selecting the setting value

With the following settings you can set a value in the submenu:



Symbol	Settings
	Brightness
	Door alarm
	Language



- ▶ Swipe left in the display until Settings  appears.
- ▶ Tap to confirm settings.
- ▶ Swipe until you see the setting you want.

- ▶ Tap briefly to confirm.
- ▶ Select the desired setting value by swiping the display.
- ▶ Tap briefly to confirm.
- ▷ You hear the confirmation tone.
- ▷ Status appears briefly in the submenu.
- ▷ Display switches back to the menu.

6.2.5 Go to the Customer menu

You can see the following settings in the Customer menu:

Symbol	Function
	TubeClean ²
	Ice cubes ¹
	Software

- ▶ Swipe left in the display until the settings  appear.
- ▶ Tap settings.
- ▷ The submenu appears.
- ▶ Swipe left in the display until the appliance information  appears.
- ▶ Press for 3 seconds.
- ▷ The input menu for a numerical code appears.
- ▶ Enter the numerical code 151.
- ▷ The customer menu appears.
- ▶ Swipe left in the display until the desired setting appears.

¹ Select the value

- ▶ Confirm with a short tap.
- ▷ You hear the confirmation tone.
- ▷ Status appears briefly in the display.
- ▷ Display switches back to the menu.

² Activate the setting

- ▶ To confirm, press the display for 3 seconds.
- ▷ You hear the confirmation tone.
- ▷ Status appears on the display.
- ▷ The symbol flashes as long as the appliance is working.

6.3 Functions

Turn off appliance

This setting turns off the whole appliance.

Switching off the entire appliance

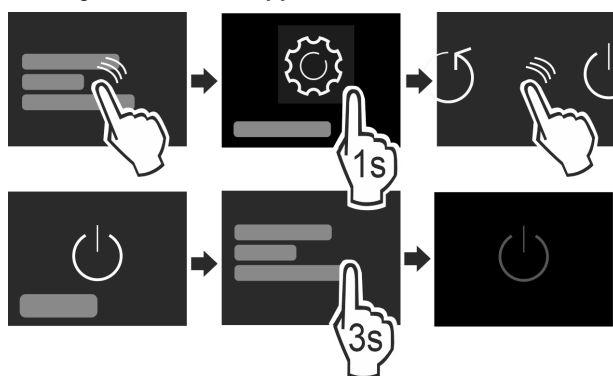

Fig. 7

- ▶ Turning off the IceMaker .
- ▶ Activating/deactivating (see 6.2 Control concept) .
- ▷ Off: Display goes black.

WiFi

Use this function to connect your appliance to the WiFi. You can then operate it via the SmartDevice app on a mobile device. You can also use this function to disconnect or reset the WiFi connection. To connect your appliance to the WiFi, you need the SmartDeviceBox. For more information about the SmartDeviceBox and how to use the SmartDevice app: (see 1.3 SmartDevice)

Note

You cannot use the SmartDeviceBox in the following countries: Belarus, Kazakhstan, Russia. The SmartDevice function is not available.

Establishing a WiFi connection

Make sure that the following requirements are fulfilled:

- You have purchased and inserted a SmartDeviceBox. (see 1.3 SmartDevice)
- You have installed the SmartDevice app (see apps.home.liebherr.com).

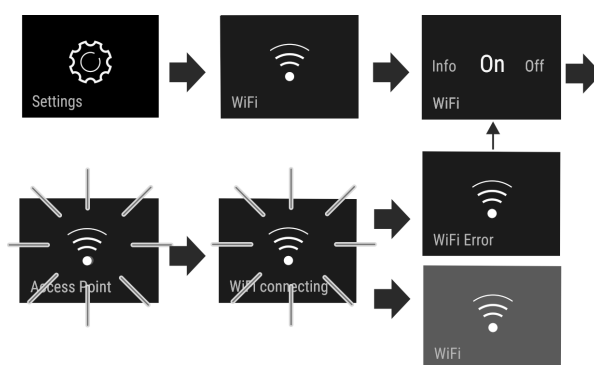

Fig. 8

- ▶ Activate the setting. (see 6.2 Control concept)
- ▷ Connection is established: Connecting appears. The symbol flashes.
- ▷ Connection is established: WiFi appears, the display turns blue.
- ▷ Connection failed: WiFi Error appears.

Disconnecting from the WiFi

- ▶ Deactivate the setting. (see 6.2 Control concept)

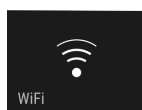
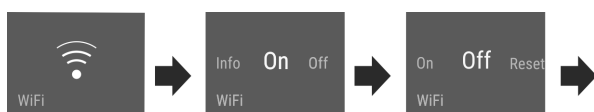



Fig. 9

- ▷ There is no connection: Symbol  is permanently visible.

Resetting the WiFi connection

- ▶ Reset settings. (see 6.2 Control concept)

Controls

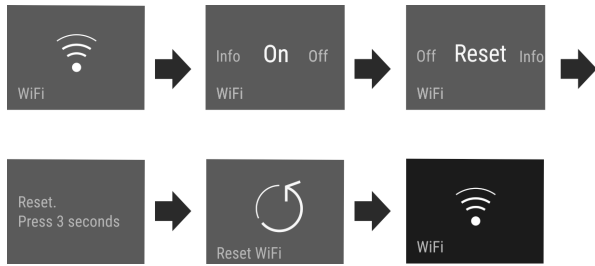

Fig. 10

- ▷ The connection and other settings are reset to the factory settings.

5 °C Temperature

The temperature depends on the following factors:

- The amount of times the door is opened
- How long the door is open for
- The room temperature of the installation site
- The type, temperature and amount of food

Freezer compartment	Recommended setting
-18 °C	-18 °C

Setting the temperature

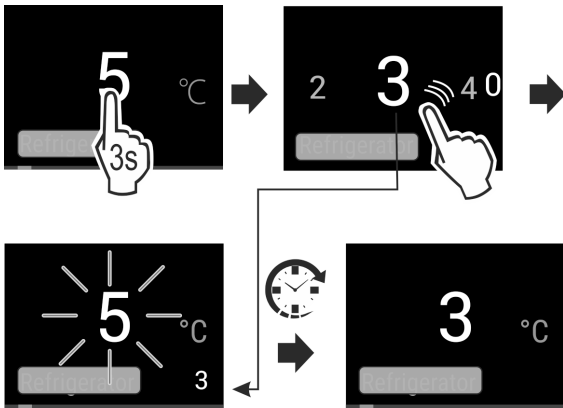

Fig. 11

- ▶ Set the value. (see 6.2 Control concept) .
- ▷ Set temperature is shown at the bottom right of the display.

* * * SuperFrost

This function selects the lowest freezing temperature. This gives you colder storage temperatures.

Use:

- For storing more than 2 kg fresh food every day.
- Freezing fresh food quickly to the core.
- Increasing the cold reserves in the stored goods before defrosting the appliance.

Activating/deactivating the function

With a small amount to freeze:

- ▶ Activate 6 hours before use.

With a maximum amount to freeze:

- ▶ Activate 24 hours before use.
- ▶ Activating/deactivating (see 6.2 Control concept) .

The function automatically turns off. The appliance goes back to normal mode. The temperature adjusts itself to the set level.

PartyMode

This option offers an assortment of special functions and settings that are useful if you are having a party.

The following functions are on:

- *SuperFrost*
- *IceMaker* and *MaxIce*

All the functions can be adjusted flexibly and separately. Changes are discarded when the function turns off.

Activating/deactivating the function

- ▶ Activating/deactivating (see 6.2 Control concept) .
 - ▷ On: All functions are activated at the same time.
 - ▷ Deactivated: Previously set temperatures are restored.
- After 24 hours the function turns off automatically.

SabbathMode

With this function you can activate or deactivate the SabbathMode. If you activate this function, some electronic functions will be switched off. This allows your appliance to meet religious requirements on Jewish holidays such as the Sabbath and comply with STAR-K Kosher certification.

Appliance status with active SabbathMode
The status display continuously shows SabbathMode.
All functions in the display except the Deactivate SabbathMode function are locked.
Active functions remain active.
The display stays lit when you close the door.
The interior lighting is off.
Reminders are disabled. The set time intervals are paused.
Reminders and warnings are not displayed.
There is no door alarm.
There is no temperature alarm.
The IceMaker is out of operation.
The defrost cycle only works for the specified time without taking account of appliance use.
After a power failure, the appliance returns to SabbathMode.

Appliance status

Note

This appliance has certification from the "Institute for Science and Halacha". (www.machonhalacha.co.il)

You can find a list of STAR-K-certified appliances at www.star-k.org/appliances.

Activating SabbathMode



WARNING

Danger of food poisoning from spoiled food!

If you have SabbathMode activated and a power failure occurs, no message appears in the status display about the power failure. Once the power is restored, the appliance continues to operate in SabbathMode. The power failure may mean that food spoils and the consumption of this food could lead to food poisoning.

After a power failure:

- ▶ Do not consume food that was frozen and has thawed out.

- ▶ Call up the settings menu. (see 6.2 Control concept)
- ▶ Swipe left or right until corresponding function is displayed.

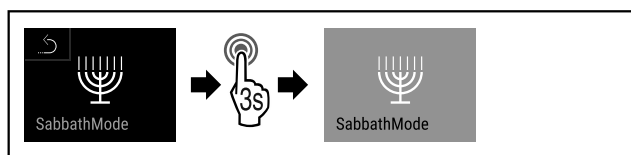

Fig. 12

- ▶ Complete the steps (see Fig. 124).
- ▷ SabbathMode is activated.
- ▷ Status display continuously shows SabbathMode.

Deactivating SabbathMode

- ▶ Call up the settings menu. (see 6.2 Control concept)
- ▶ Swipe left or right until corresponding function is displayed.

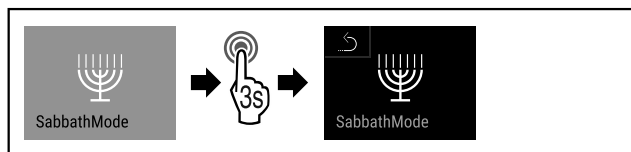

Fig. 13

- ▶ Complete the steps (see Fig. 125).
- ▷ SabbathMode is deactivated.

EnergySaver

This function reduces energy consumption. If you activate this function, the cooling temperature increases.

Temperature zone	Recommended setting	Temperature when EnergySaver activated
-18 °C	-18 °C	-16 °C

Use:

- Save energy.

Activating/deactivating the function

- ▶ Activating/deactivating (see 6.2 Control concept).
- ▷ Activated: Higher temperatures are set in all temperature zones.
- ▷ Deactivated: Previously set temperatures are restored.

IceMaker / MaxIce

This function creates ice cubes.

Use:

- If this function is activated, you can decide between the normal IceMaker function and MaxIce.
- The MaxIce function enables your appliance to make approx. 1.5 kg of ice cubes per 24 h within a short time.

The ice cube size can be set with the **ice cube size** function. (see Ice cubes)

The lines can be cleaned with the **TubeClean** function. (see TubeClean)

Activating the function

Ensure that the following conditions are met:

- The water supply is established at the fixed water connection. See installation instructions.
- IceMaker is put into operation. (see 7.4 IceMaker)

- ▶ Activate the function. (see 6.2 Control concept)

-or-

- ▶ Activate the function via the Liebherr SmartDevice-App.

- ▷ It can take up to 24 hours for the first ice cubes to be made.

Deactivating the function

- ▶ Deactivate the function. (see 6.2 Control concept)
- ▷ If ice cubes are currently being made, the system completes the process. After that, the IceMaker switches off.

5

Ice cubes

Set the ice cube size.

Choose the setting

- ▶ Set the size in the Customer menu (see 6.2 Control concept).



TubeClean

This setting cleans the IceMaker pipes.

Ensure that the following conditions are met:

- IceMaker cleaning is ready (see 8.3.4 Cleaning the IceMaker).

Activating the setting

- ▶ Activate the setting in the Customer menu (see 6.2 Control concept).
- ▷ The rinse process is ready (max. 60 min.): Symbol flashes.
- ▷ Water pipes are rinsed: Symbol flashes.
- ▷ Rinsing process is complete: Function turns off automatically.



Display brightness

Set the brightness level of the display.

You can set the following brightness levels:

- 40%
- 60%
- 80%
- 100%

Choose the setting

- ▶ Set the level (see 6.2 Control concept).

Controls



Door alarm

Set the time before the door alarm (see Close the door) sounds.

The options are as follows:

- 1 min
- 2 min
- 3 min
- Off

Choose the setting

- ▶ Set the time (see 6.4 Fault messages) .



Entry lock

This setting prevents unintentional use of the appliance, e.g. by children.

Use:

- Avoid settings being changed unintentionally.
- Avoid the appliance being switched off unintentionally.
- Avoid the temperature being changed unintentionally.

Activating/deactivating settings

- ▶ Activating/deactivating. (see 6.2 Control concept)

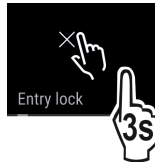

Language

This setting lets you choose the language of the display.

Choose from the following languages:

- German
- English
- French
- Spanish
- Italian
- Dutch
- Czech
- Polish
- Portuguese
- Russian
- Chinese

Activating/deactivating settings

- ▶ Activating/deactivating (see 6.2 Control concept) .



Info

This setting allows the appliance information to be read out as well as access to the customer menu.

It provides the following information:

- Model name
- Index
- Serial number
- Service number

Show appliance data

- ▶ Swipe in the display until Settings  appears.
- ▶ Confirm the display.
- ▶ Swipe in the display until About appears.
- ▶ Read the appliance info.



Reminder

Reminders are given out acoustically by a beep and visually by a symbol in the display. The signal gets louder until the alert stops.

Activating the setting

- ▶ Activating/deactivating (see 6.2 Control concept) .



Reset

This function resets all settings to the factory settings. All settings that you have made thus far will be reset to their original values.

Activating the setting

- ▶ Activate (see 6.2 Control concept) .

6.4 Fault messages

Fault messages appear in the display. There are two categories of fault message:

Category	Meaning
Message	Reminder of general procedures. You can carry out these procedures to eliminate the message.
Warning	Appears when there are malfunctions. A signal sounds in addition to the display. The signal becomes louder until you acknowledge by tapping the display. You can eliminate simple defects yourself. For more serious defects, you must contact customer service.

6.4.1 Warnings



Close the door

This message appears if the door is open for too long.

You can set how long it takes for this message to appear .

- ▶ Stop alarm: Confirm the message.

-or-

- ▶ Close the door.



Power cut

This message appears if the freezer temperature increased due to a power cut. After the power is restored, the appliance continues to work at the set temperature.

- ▶ Stop alarm: Confirm the message.

▷ Temperature alert appears (see Temperature alarm) .



Temperature alarm

This message appears if the temperature does not match the set temperature.

Variations in temperature could be because:

- Hot, fresh food was inserted.
- Too much warm room air flowed in when rearranging and removing food.

- The power was cut off for a while.
- The appliance is faulty.

When the fault is eliminated the appliance continues to work at the set temperature.

- ▶ Confirm the display.
- ▷ The highest temperature is shown.
- ▶ Confirm display again.
- ▷ The status display is displayed.
- ▷ The current temperature is shown.



Error

This message appears if there is a fault with the appliance. An appliance component indicates a fault.

- ▶ Open the door.
- ▶ Note down the fault code.
- ▶ Confirm the message.
- ▷ The signal tone stops.
- ▷ The status display appears.
- ▶ Close the door.
- ▶ Contact customer service. (see 9.4 Customer Services)

6.4.2 Message



Insert IceMaker drawer

This message appears if the IceMaker drawer is open.

- ▶ Push in the IceMaker drawer.
- ▷ The message disappears.
- ▷ The IceMaker produces ice cubes.

6.4.3 DemoMode

If "D" appears on the display, demo mode is on. This option is designed for retailers, as it turns off all the cooling functions.

Stopping DemoMode

If you see the following running in the display:

- ▶ Confirm the display within the countdown.
- ▷ DemoMode is off.
- If the timer is not running:
- ▶ Unplug the appliance.
- ▶ Plug the appliance in again.
- ▷ DemoMode is off.

7 Features

7.1 Drawers

You can remove the drawers for cleaning.

You can remove the drawers to use VarioSpace.

The way to remove/insert the drawers varies depending on the pull-out system. Your appliance can contain various pull-out systems.

Note

The energy consumption increases and the cooling power goes down if ventilation is not sufficient.

- ▶ Leave the bottom drawer in the appliance!
- ▶ Always leave the fan air vents clear on the back wall!

7.1.1 Drawer on appliance base or glass shelf

The drawer runs directly on the appliance base or on a glass shelf. There are no rails.

When you remove the drawers, you can use the glass shelves below them as storage shelves.

Removing drawer

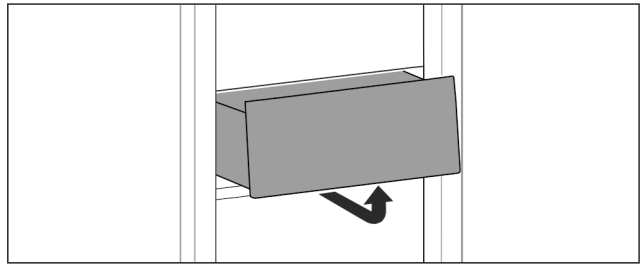

Fig. 14

- ▶ Remove drawer as shown in the illustration.

Inserting drawer

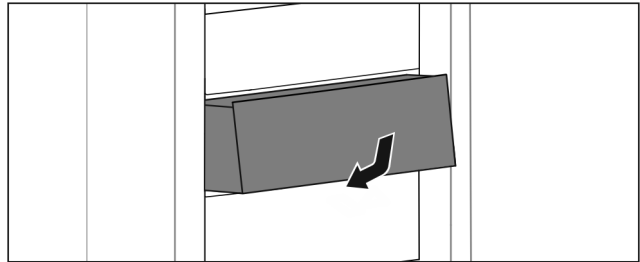

Fig. 15

- ▶ Insert drawer as shown in the illustration.

7.1.2 Drawer on telescopic rails*

The drawer runs on extendible rails (telescopic rails). There are fully extendible telescopic rails and telescopic rails with partial pull-out. Drawers which are fully extendible can be pulled out fully from the appliance. Drawers with partial pull-out cannot be removed fully from the appliance. The system in your appliance depends on the type of appliance.

Drawer on glass shelf

The drawer guided on a glass shelf is a partial pull-out.

Removing drawer

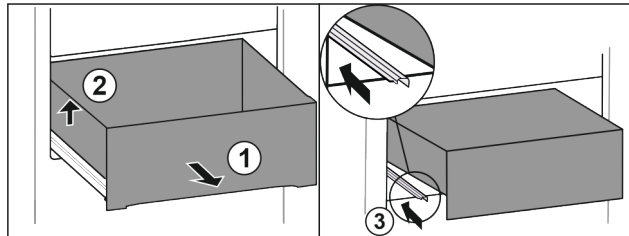

Fig. 16

- ▶ Pull out drawer as far as it will go. Fig. 16 (1)
- ▶ Lift drawer on the left. Fig. 16 (2)
- ▶ Insert left rail. Fig. 16 (3)

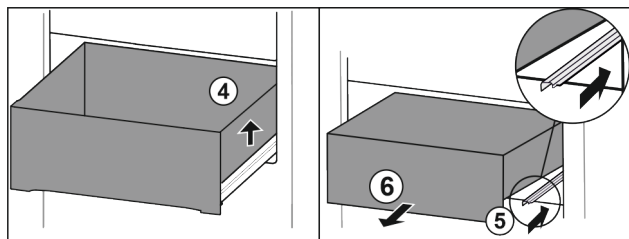

Fig. 17

- ▶ Lift drawer on the right. Fig. 17 (4)
- ▶ Insert right rail. Fig. 17 (5)
- ▶ Remove drawer to the front. Fig. 17 (6)

Features

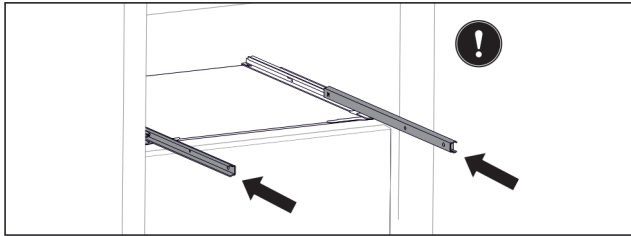

Fig. 18

If the rails are not yet fully inserted after removing the drawer:

- ▶ Push rails in completely.

Inserting drawer

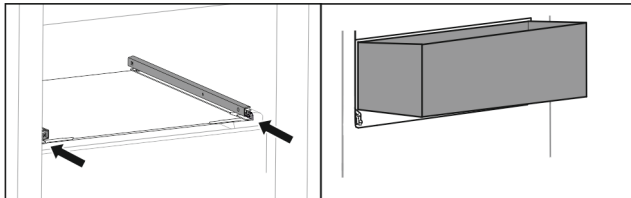

Fig. 19

- ▶ Slide rails in.
- ▶ Place drawer on rails at an angle.

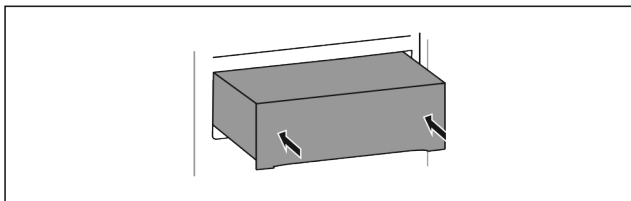

Fig. 20

- ▶ Lower drawer.
- ▶ Slide in drawer to the back.

7.1.3 Top tilting drawer

When you pull out the top drawer, it tilts forward. This gives you a better view into the drawer. The function depends on the height of the appliance.

When you remove the tilting drawers, you can use the glass shelf below them as a storage shelf.

Removing drawer

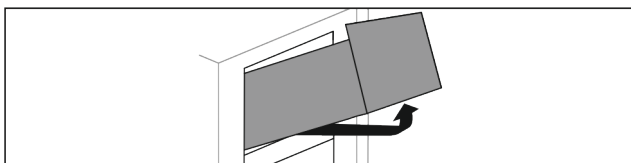

Fig. 21

- ▶ Pull out drawer as far as it will go.
- ▶ Lift drawer up at the front and at the same time push up at the back from below.
- ▶ Remove drawer to the front.

Inserting drawer

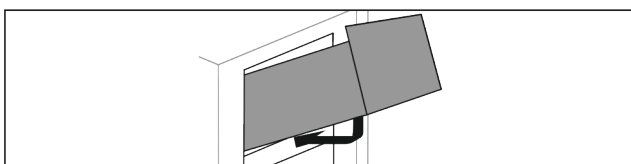

Fig. 22

- ▶ Position drawer as shown.
- ▷ The drawer rests on the glass panel.
- ▶ Lift drawer slightly from below at the back and slide over the lip.
- ▶ Slide in drawer to the back.

7.1.4 Drawer on moulded rib*

The drawer runs directly on the moulded rib. There are no rails.

Removing drawer

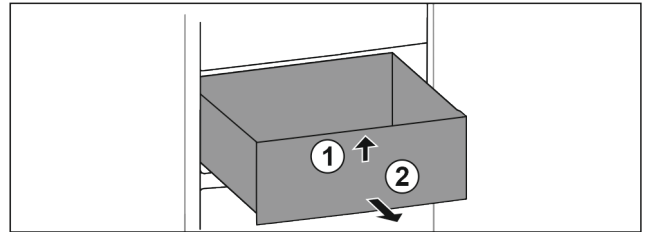

Fig. 23

- ▶ Pull out drawer as far as it will go.
- ▶ Lift up drawer at the front. Fig. 23 (1)
- ▶ Remove drawer to the front. Fig. 23 (2)

Inserting drawer

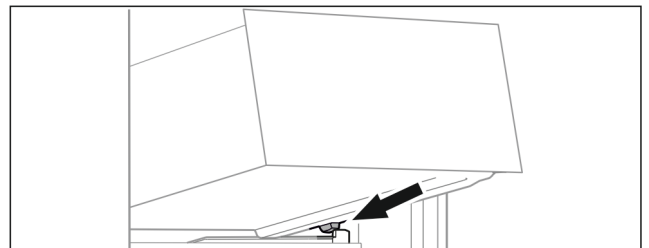

Fig. 24

- ▶ Place drawer at an angle behind the stoppers on the moulded rib. (see Fig. 136)
- ▶ Lower drawer.
- ▶ Slide in drawer to the back.

7.2 Pull-out board with IceTower

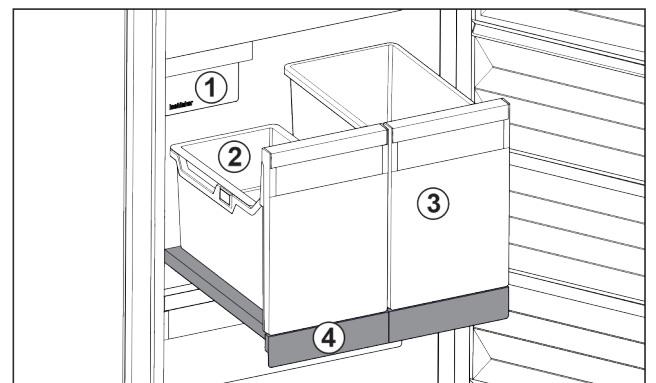

Fig. 25 Pull-out board with IceTower

- | | |
|--------------------------------|---|
| (1) IceMaker | (3) Container for pizza or alcoholic beverages, for example |
| (2) Hang-on tray for ice cubes | (4) Pull-out board |

There are two high (IceTower) containers on the pull-out board. Ice cubes from the IceMaker are collected and stored in the Fig. 25 (2) container. The container Fig. 25 (3) is suitable for storing tall foodstuffs or beverages such as pizzas or alcoholic drinks.

The pull-out board with IceTower is mounted on a glass shelf with pull-out rails. You can dismantle the pull-out board for cleaning.

7.2.1 Dismantling the pull-out board with IceTower

Removing the container

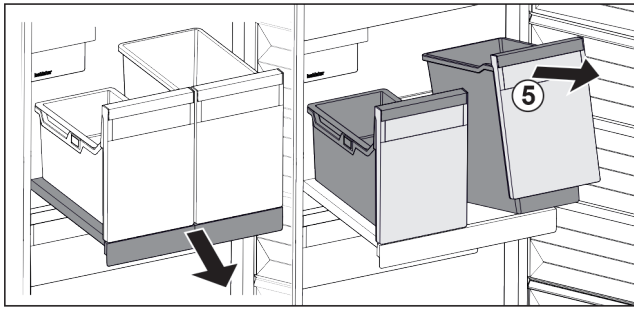

Fig. 26

- ▶ Pull out the pull-out board.
- ▶ Lift the container Fig. 26 (5) at the front.
- ▶ Remove the container.

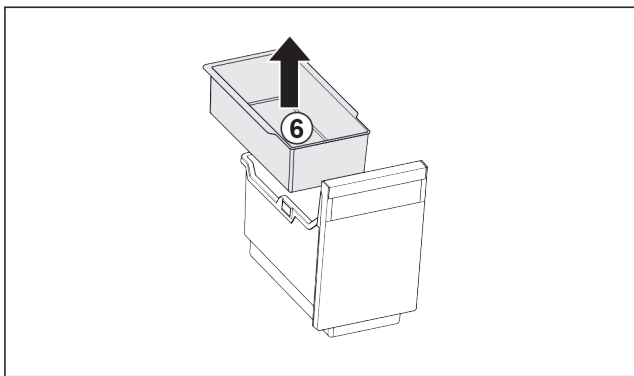

Fig. 27

- ▶ Remove the hang-on tray Fig. 27 (6).
- ▶ If there are ice cubes in the hang-on tray: Empty the hang-on tray.
- ▷ The container and hang-on tray have been removed and you can clean them. (see 8.3.3 Clean the components)

Removing the pull-out board

Ensure that the following conditions are met:

- Containers have been removed. (see 7.2.1.1 Removing the container)

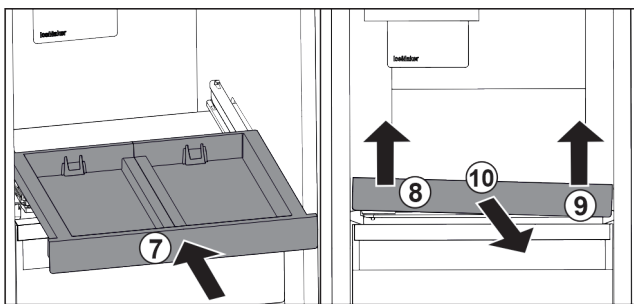

Fig. 28

- ▶ Slide in the pull-out board. Fig. 28 (7)
- ▶ Lift the pull-out board on the front left. Fig. 28 (8)
- ▶ Lift the pull-out board on the front right. Fig. 28 (9)
- ▷ Pull-out board is detached from the attachment at the front.
- ▶ Take out the pull-out board to the front. Fig. 28 (10)
- ▷ The pull-out board has been removed and you can clean it. (see 8.3.3 Clean the components)

Removing the glass shelf from under the pull-out board

(see 7.3 Glass shelves)

7.2.2 Inserting the pull-out board with IceTower

Inserting the glass shelf from under the pull-out board

(see 7.3 Glass shelves)

Inserting the pull-out board

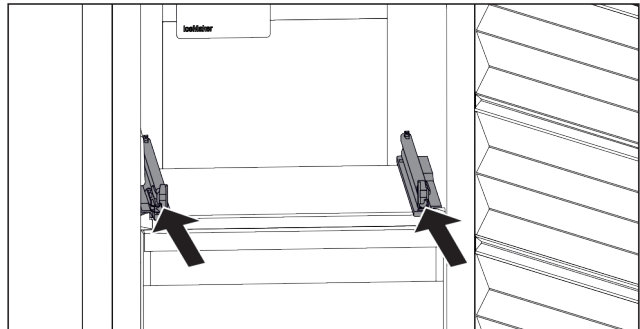

Fig. 29

- ▶ Slide the rails in.

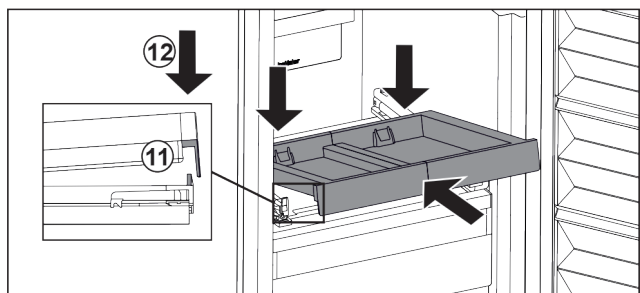

Fig. 30

- ▶ Place the pull-out board in at an angle behind the front lug.
- ▶ Slide in at an angle. Make sure that the stop is behind the lug on both sides. Fig. 30 (11)
- ▶ Lower the pull-out board at the front. Fig. 30 (12)

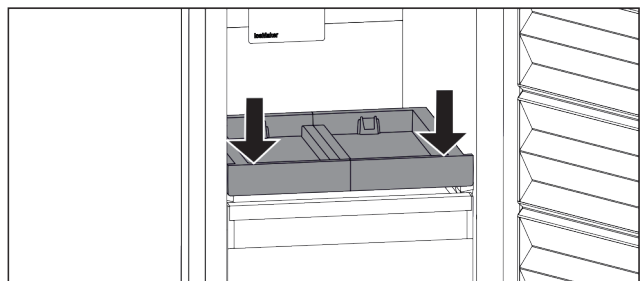

Fig. 31

- ▶ Push the pull-out board down at the front.
- ▷ Pull-out board clicks into place.

Inserting the container

Ensure that the following conditions are met:

- The pull-out board is inserted. (see 7.2.2.2 Inserting the pull-out board)

Features

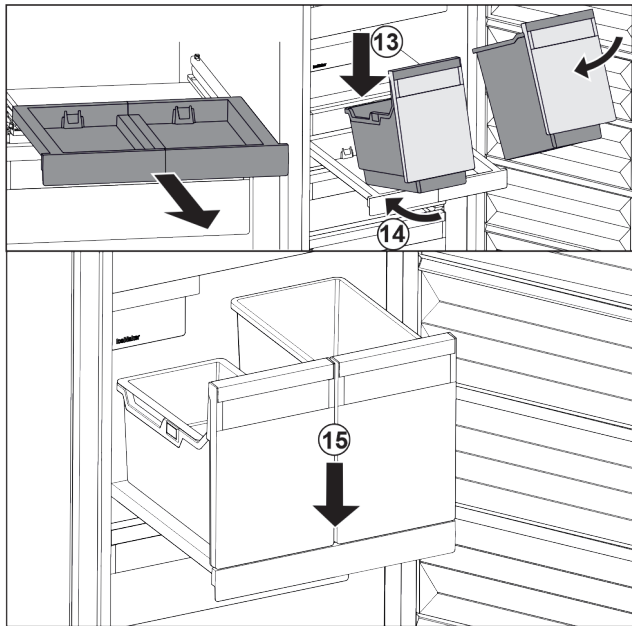

Fig. 32

- ▶ Pull out the pull-out board.
- ▶ Hold the pull-out board with one hand.

Note

The containers are shaped in a way that they cannot be interchanged.

- ▶ Place the container at an angle on the pull-out board. Fig. 32 (13)
- ▶ Slide the container to the back at an angle. Fig. 32 (14)
- ▶ Place container in the front. Fig. 32 (15)

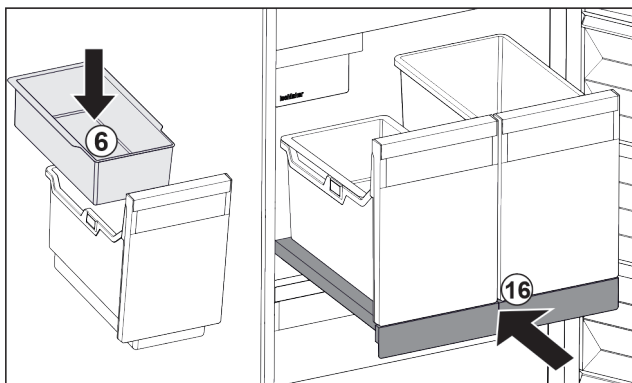

Fig. 33

- ▶ Insert hang-on tray Fig. 33 (6) for ice cubes.
- ▶ Slide in the pull-out board with (IceTower) container. Fig. 33 (16)
- ▷ Pull-out shelf with IceTower is fully inserted.

7.3 Glass shelves

NOTICE

Impermissible removal of the glass panel above the IceTower!

Damage to the IceMaker. The IceMaker is attached to the glass panel above the IceTower.

- ▶ Do not remove the glass panel above the IceTower.

You can remove the glass shelves under the drawers for cleaning.

You can remove the glass shelves under the drawers to use VarioSpace.

7.3.1 Removing / inserting the glass shelf under the tilting drawer

The glass shelf is located under the top tilting drawer.

Make sure that the following requirements are fulfilled:

- Drawer has been removed. (see 7.1.3 Top tilting drawer)

Removing glass shelf

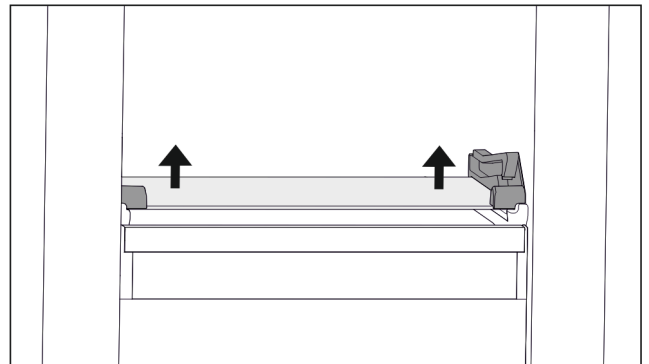

Fig. 34 Tilting drawer glass shelf

- ▶ Push glass shelf upwards from below on both sides. (see Fig. 146)
- ▶ Take out the glass shelf to the front.

Inserting glass shelf

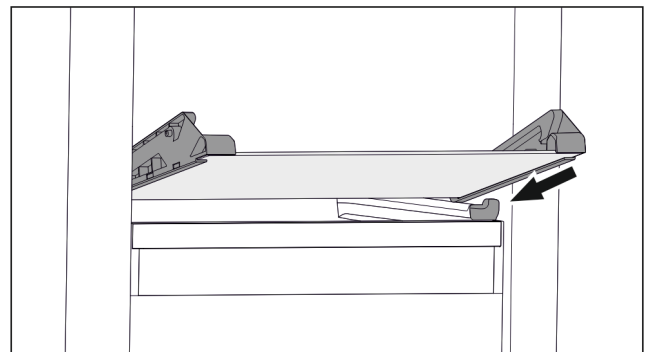

Fig. 35 Tilting drawer glass shelf

- ▶ Position glass shelf at an angle behind the stoppers. (see Fig. 147)
- ▶ Lower glass shelf.
- ▶ Slide in glass shelf to the back.
- ▷ Glass shelf clicks into place.

7.3.2 Removing / inserting the glass shelf

Depending on the equipment, the glass shelf may be located under the drawer.

Depending on the equipment, the glass shelf may be located under the IceTower.

Make sure that the following requirements are fulfilled:

- Glass shelf under the drawer: The drawer has been removed. (see 7.1 Drawers)
- Pull-out board under IceTower: IceTower has been removed. (see 7.2 Pull-out board with IceTower)

Removing glass shelf

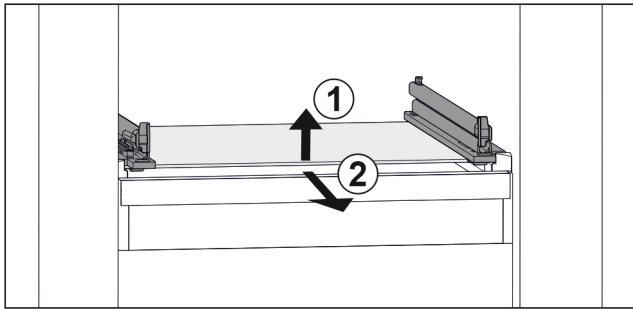

Fig. 36 Example illustration of glass shelf

- ▶ Lift glass shelf at the front. Fig. 36 (1)
- ▶ Take out glass shelf to the front. Fig. 36 (2)

Inserting glass shelf

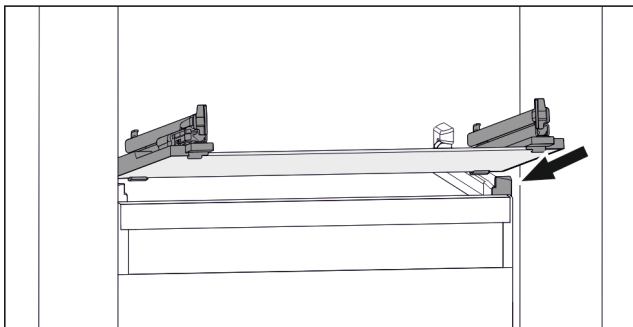

Fig. 37 Example illustration of glass shelf

- ▶ Position glass shelf at an angle behind the stoppers. (see Fig. 149)
- ▶ Lower glass shelf.
- ▶ Slide in glass shelf to the back.

7.4 IceMaker

The IceMaker will produce ice cubes for household use only.

Ensure that the following conditions are met:

- IceMaker is cleaned (see 8 Maintenance) .
- IceMaker drawer is fully inserted.

7.4.1 Producing ice cubes

The volume depends on the freezing temperature. The colder the temperature, the more ice cubes the system can produce in a certain time period.

After the IceMaker is turned on for the first time, it can take up to 24 hours for the first ice cubes to be made.

- ▶ Activate the IceMaker function (see 6.2 Control concept) .
- ▶ To make a high number of ice cubes: Activate the MaxIce function (see 6.2 Control concept) .
- ▶ Distribute the ice cubes evenly in the drawer to increase the capacity.
- ▶ Closing the drawer: IceMaker starts making ice cubes again automatically.

Note

When a certain level is reached in the IceMaker drawer, it stops producing ice cubes. The IceMaker does not fill the drawer all the way to the top.

7.5 VarioSpace

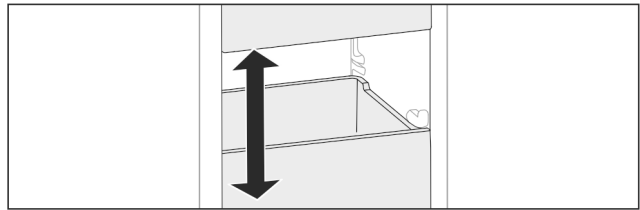

Fig. 38

You can remove drawers and glass panels from your appliance. This provides more room for large food items such as poultry, joints of meat, large game, and tall baked products. You can then freeze these items whole for later preparation.

- ▶ Note the weight limits on the drawers and glass panels (see 9.1 Technical specifications) .

7.6 Accessories

7.6.1 Freezer pack

Freezer packs prevent the temperature rising too quickly should there be a power cut.

The freezer packs are in the drawer.

You can store the freezer packs in the freezer tray.

Using the freezer pack

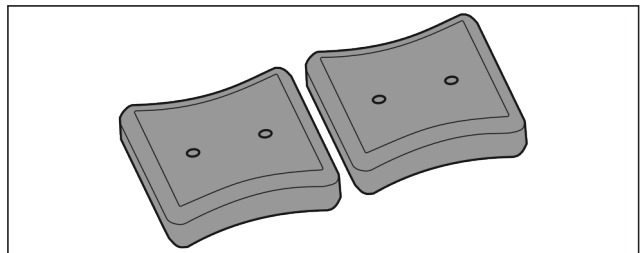

Fig. 39

When the freezer packs are fully frozen:

- ▶ Place on the frozen goods in the top, front part of the freezer.

8 Maintenance

8.1 Disassembling / assembling pull-out systems

8.1.1 Notes on disassembly

You can disassemble some of the pull-out systems for cleaning. Your appliance can contain a variety of pull-out systems.

The following pull-out systems can be disassembled or cannot be disassembled:

Pull-out system	can be disassembled / cannot be disassembled
Drawer on appliance base or glass shelf	cannot be disassembled
Drawer on glass shelf	can be disassembled (see 8.1.2.1 Drawer on glass shelf)
Top tilting drawer	can be disassembled (see 8.1.3 Top tilting drawer)
Drawer on moulded rib*	can be disassembled (see 8.1.4 Drawer on moulded rib*) *

Pull-out system	can be disassembled / cannot be disassembled
IceTower	can be disassembled (see 8.1.5 IceTower)

8.1.2 Drawer on telescopic rails*

Drawer on glass shelf

Disassembling pull-out system

Make sure the following prerequisites are met:

- Drawer has been removed.
- Glass shelf has been removed. (see 7.3 Glass shelves)

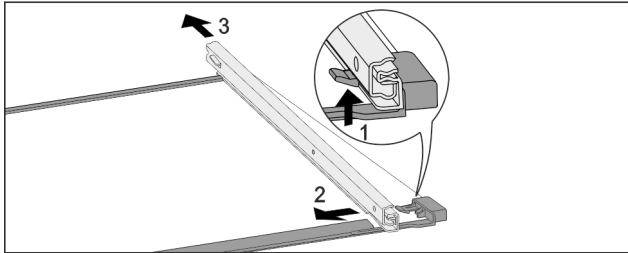

Fig. 40 Glass shelf with rails

- ▶ Push up front click-in hooks. (1)
- ▶ Move pull-out rails to the side (2) and to the rear (3).

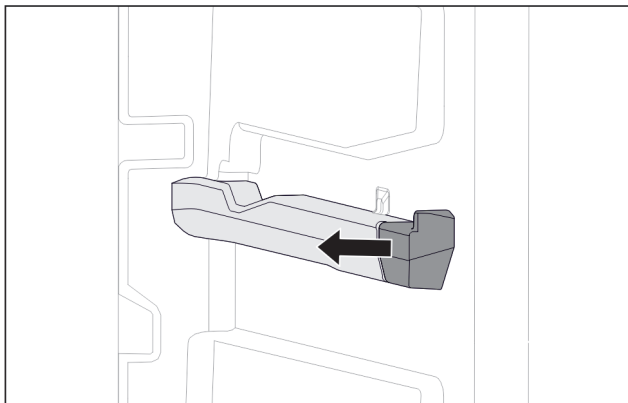

Fig. 41 Attachment on the right moulded rib

- ▶ Remove moulded rib attachment sideways.

Installing pull-out system

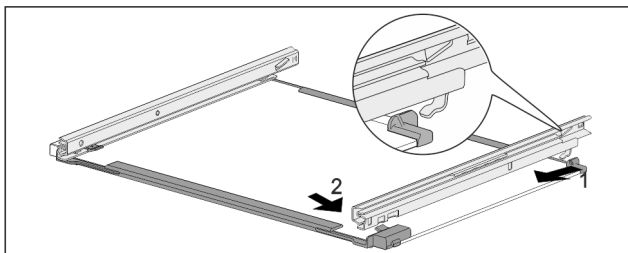

Fig. 42 Glass shelf with rails

- ▶ Hook in rail at the back. (1)
- ▶ Hook in rail at the front. (2)

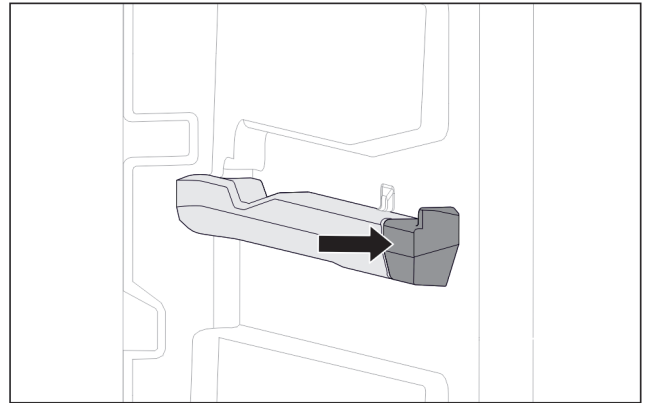

Fig. 43 Attachment on the right moulded rib

- ▶ Press attachment onto moulded rib.

8.1.3 Top tilting drawer

Disassembling pull-out system

Make sure the following prerequisites are met:

- Drawer has been removed. (see 7.1.3 Top tilting drawer)
- Glass shelf has been removed. (see 7.3 Glass shelves)

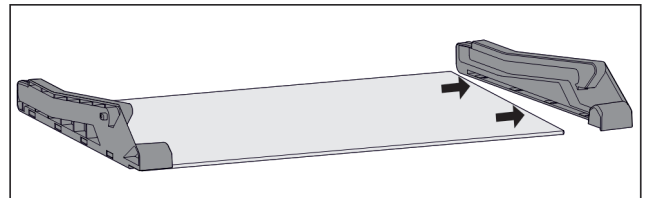

Fig. 44 Glass shelf with side parts

- ▶ Pull off side part from glass shelf sideways.

Installing pull-out system

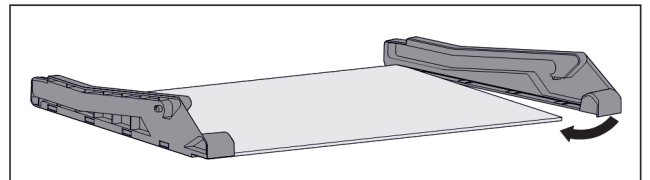

Fig. 45 Glass shelf with side parts

- ▶ Place on side part at the back.
- ▶ Press side part onto glass shelf at the front.

8.1.4 Drawer on moulded rib*

Disassembling pull-out system

Make sure the following prerequisites are met:

- Drawer has been removed. (see 7.1.4 Drawer on moulded rib*)

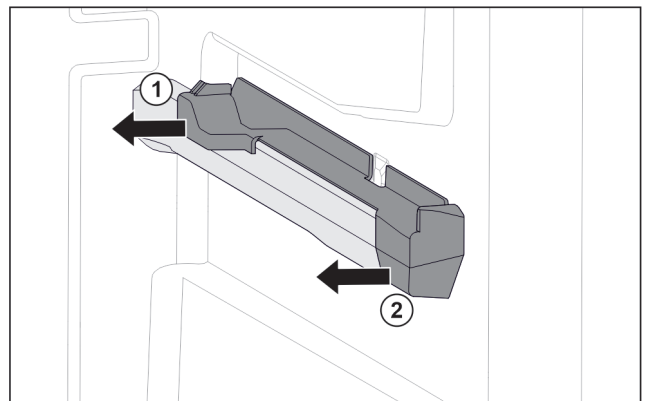

Fig. 46 Attachment on the right moulded rib

- ▶ Grab attachment at the back from below.

- ▶ Pull off attachment at the back sideways. Fig. 46 (1)
- ▶ Pull off attachment at the front sideways. Fig. 46 (2)

Installing pull-out system

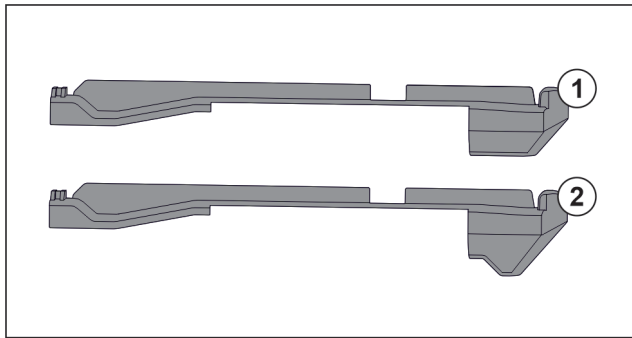

Fig. 47 Comparing attachments

There are two different attachments in the appliance. The attachment above the lowest drawer Fig. 47 (2) has a three-cornered edge. All other attachments Fig. 47 (1) have a straight edge.

- ▶ Fit attachment Fig. 47 (2) with the three-cornered edge above the lowest drawer.
- ▶ Fit attachment Fig. 47 (1) with straight edge in all other positions.

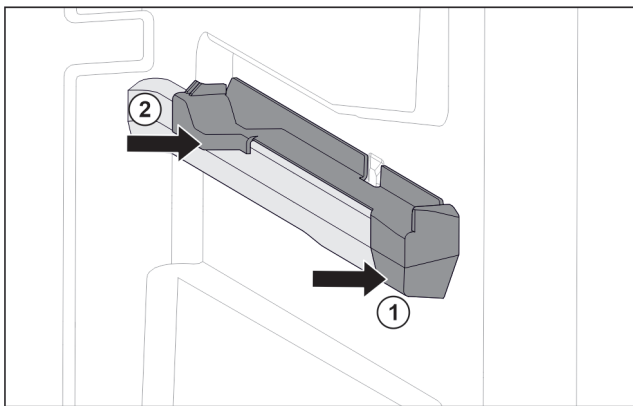

Fig. 48 Attachment on the right moulded rib

- ▶ Position attachment on moulded rib at the front. Fig. 48 (1)
- ▶ Press on attachment at the back. Fig. 48 (2)

8.1.5 IceTower

Disassembling pull-out system

Make sure the following prerequisites are met:

- IceTower has been removed. (see 7.2 Pull-out board with IceTower)
- Glass shelf has been removed. (see 7.3 Glass shelves)
- ▶ Place pull-out board on a table.
- ▷ You are able to remove the rails more easily from the glass shelf.

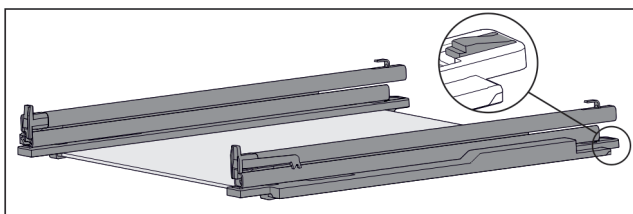

Fig. 49 Glass shelf with rails and retaining parts

- ▶ Press down retaining part at the rear (see Fig. 161) and at the same time push the rail back.

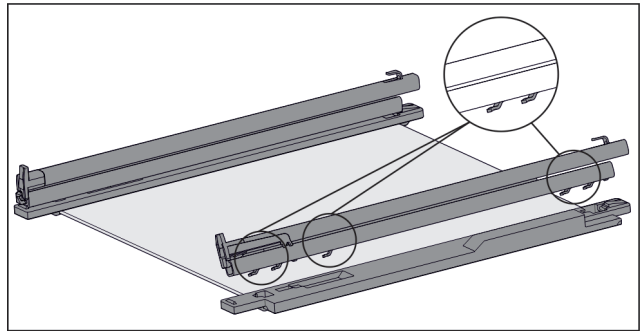

Fig. 50 Glass shelf with rails and retaining parts

- ▷ The rail hooks are released from the retaining part.
- ▶ Remove rail from retaining part.

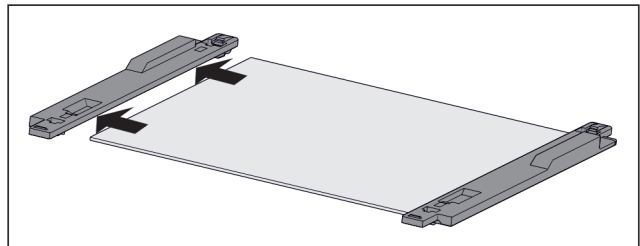

Fig. 51 Glass shelf with retaining part

- ▶ Remove retaining part from glass shelf sideways.

Installing pull-out system

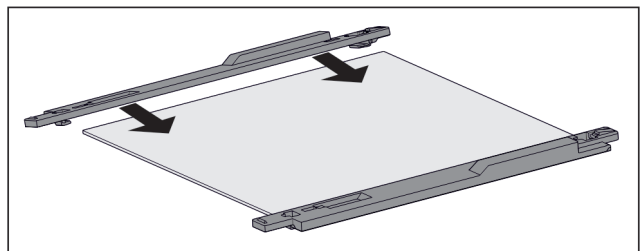

Fig. 52 Glass shelf with retaining part

- ▶ Fit retaining part on glass shelf.
- ▶ Push retaining part onto glass shelf as far as it will go.

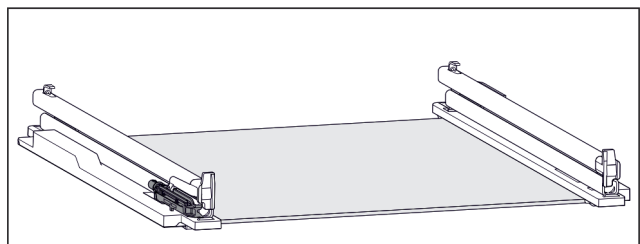

Fig. 53 Damping mechanism

The damping mechanism is attached to the left rail. (see Fig. 165) There is no damping mechanism attached to the right rail.

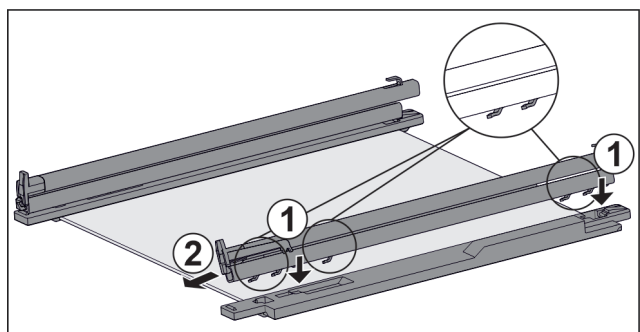

Fig. 54 Glass shelf with rails and retaining parts

Install rail **with** damping mechanism:

Maintenance

- ▶ Place rail hooks onto the openings of the **left** retaining part. *Fig. 54 (1)*
- ▶ Push rail forwards. *Fig. 54 (2)*
- ▷ Rail latches in audibly.
Install rail **without** damping mechanism:
- ▶ Place rail hooks onto the openings of the **right** retaining part. *Fig. 54 (1)*
- ▶ Push rail forwards. *Fig. 54 (2)*
- ▷ Rail latches in audibly.

8.2 Defrosting the appliance

8.2.1 Defrosting with NoFrost

Defrosting is performed automatically with the NoFrost system. The moisture is deposited on the evaporator, is periodically defrosted and evaporates.

The appliance does not need to be defrosted.

8.3 Cleaning the appliance

8.3.1 Ready



WARNING

Danger of electric shock!

- ▶ Remove the refrigerator connector or interrupt the power supply.



WARNING

Risk of fire

- ▶ Do not damage the refrigeration circuit.

- ▶ Empty the appliance.
- ▶ Remove mains connector.

8.3.2 Cleaning the interior

NOTICE

Improper cleaning!
Damage to the appliance.

- ▶ Only use soft cleaning cloths and ph-neutral all-purpose cleaners.
- ▶ Do not use abrasive sponges or steel wool which may cause scratches.
- ▶ Do not use any sharp or abrasive cleaning agents, nor any that contain sand, chloride or acid.

- ▶ Plastic surfaces: clean by hand with a soft clean cloth, lukewarm water and a little detergent.
- ▶ Metal surfaces: clean by hand with a soft clean cloth, lukewarm water and a little detergent.
- ▶ Drain hole: remove deposits using a thin item (for example a cotton bud).

8.3.3 Clean the components

NOTICE

Improper cleaning!
Damage to the appliance.

- ▶ Only use soft cleaning cloths and ph-neutral all-purpose cleaners.
- ▶ Do not use abrasive sponges or steel wool which may cause scratches.
- ▶ Do not use any sharp or abrasive cleaning agents, nor any that contain sand, chloride or acid.

Clean with a soft, clean cloth, lukewarm water and some detergent:

- IceTower pull-out board
- Drawer
Please note: Do not remove the magnet on the drawer. The magnet ensures the functionality of the IceMaker.
- Freezer tray

Clean with a damp cloth:*

- Retractable rails
Please note: The grease in the tracks is used for lubrication and must not be removed!

Wash in the dishwasher up to 60 °C:

- Ice cube scoop
- ▶ To disassemble components: see the relevant section.
- ▶ Clean the components.

8.3.4 Cleaning the IceMaker

There are various options for cleaning the IceMaker.

Cleaning is required in the following cases:

- Initial operation
- If out of use for more than 5 days.

Ensure that the following conditions are met:

- IceMaker drawer is emptied.
- IceMaker drawer is in place.
- The IceMaker is activated. (see 6.2 Control concept)

First use or after a long period of non-use

Clean the IceMaker with the TubeClean function.

- ▶ Place a 1.5 l empty container (max. height 10 cm) into the drawer under the IceMaker.
- ▶ Activate the TubeClean function. (see 6.2 Control concept)
- ▷ The rinse process is prepared (max. 60 min.): Symbol flashes.
- ▷ Water pipes are rinsed: Symbol flashes.
- ▷ Rinse process is complete: Function turns off automatically.
- ▶ Remove the IceMaker drawer and remove the container.
- ▶ Clean the IceMaker drawer with warm water and a little detergent.
- ▶ Push the IceMaker drawer in.
- ▷ The system starts making ice cubes automatically.
- ▶ Dispose of any ice cubes that were made 24 hours after the first ice cubes.

If cleaning is required

Clean the IceMaker by hand.

- ▶ Remove the IceMaker drawer and clean with warm water and a little detergent.
- ▶ Push the IceMaker drawer in.
- ▷ The system starts making ice cubes automatically.

8.3.5 After cleaning

- ▶ Wipe the appliance and the components dry.
- ▶ Connect and switch on the appliance.
- ▶ Activate SuperFrost (see 6.3 Functions).
The temperature is cold enough:
- ▶ Place the food inside.
- ▶ Repeat cleaning regularly.

9 Customer help

9.1 Technical specifications

Temperature range	
Freeze	-28 °C to -15 °C

Maximum freezer quantity / 24 hrs	
Freezer compartment	See the type plate under "Freezer goods ... /24 hours"

Maximum component capacity			
Features	Appliance width 550 mm (see installation instructions, appliance dimensions)	Appliance width 600 mm (see installation instructions, appliance dimensions)	Appliance width 700 mm (see installation instructions, appliance dimensions)
Drawer on glass shelf (see 7.1.1 Drawer on appliance base or glass shelf)	12 kg	15 kg	--
Drawer on moulded rib* (see 7.1.4 Drawer on moulded rib*) *	14 kg*	19 kg*	19 kg*
Drawer on glass shelf (see 7.1.2 Drawer on telescopic rails*)	12 kg	15 kg	22 kg

Maximum load weight of equipment in kg	
Equipment	Appliance width 600 mm (see installation instructions, appliance dimensions)
Drawer on glass shelf (see 7.1.1 Drawer on appliance base or glass shelf)	22
Drawer on glass shelf (see 7.1.2 Drawer on telescopic rails*)	22

Ice cube production with IceMaker*	
Ice cube production / 24 h	At a temperature of -18 °C: 0.8 kg of ice cubes
Maximum ice cube production / 24 hours	With the MaxIce function on: 1.2 kg of ice cubes

9.2 Operating noises

The appliance makes different noises when it is on.

- At **higher temperatures** the appliance uses less energy but works for longer. It is **quieter**.
- At **lower temperatures** the food is cooled faster. It is **louder**.

Examples:

- Functions on (see 6.3 Functions)
- Fan running
- Food recently added
- High ambient temperature
- Door open for a while

Noise	Possible cause	Type of noise
Bubbling and splashing	Coolant flowing into the cooling circuit.	Normal operating noise
Hissing	Coolant sprays into the cooling circuit.	Normal operating noise
Humming	The appliance is cooling. The volume depends on the cooling output.	Normal operating noise
Suction noises	Soft-closing door is being opened and closed.	Normal operating noise
Humming and rustling	The fan is running.	Normal operating noise
Clicking	Components are switched on and off.	Normal switching noise
Rattling humming or	Valves or flaps are working.	Normal switching noise

Noise	Possible cause	Type of noise	Lifting
Vibration	Improper installation	Defective noise	Check the installation. Level the appliance.
Rattling	Components, items inside the appliance	Defective noise	Secure components. Leave enough space between the items.

9.3 Technical fault

Your appliance is designed and built to ensure it works reliably and has a long service life. In the unlikely event that a fault occurs during operation, please check whether it is due to an operating error. If so, you will be charged for the callout and repair costs even if it falls within the warranty period.

You can fix the following faults yourself.

Customer help

9.3.1 Appliance function

Defect	Cause	Remedy
The appliance is not working.	→ The appliance is not switched on.	▶ Switch the appliance on.
	→ The power plug is not properly plugged into the socket.	▶ Check the power plug.
	→ There is something wrong with the power outlet fuse.	▶ Check the fuse.
	→ Power cut	▶ Keep the appliance closed. ▶ Protecting food: Lay freezer packs on top of the food or use another freezer if the power is off for a prolonged period. ▶ Do not re-freeze defrosted food,
	→ The appliance plug does not fit the appliance properly.	▶ Check the appliance plug.
Temperature is not cold enough.	→ The appliance door is not closed properly.	▶ Close the appliance door.
	→ Not enough ventilation.	▶ Keep ventilation grille clear, and clean it.
	→ The ambient temperature is too high.	▶ Solution: (see 1.4 Appliance range of use) .
	→ The appliance was opened too many times or for too long.	▶ Wait to see if the required temperature corrects itself. If not, contact Customer Service (see 9.4 Customer Services) .
	→ Too much fresh food was placed inside without SuperFrost.	▶ Solution: (see SuperFrost)
	→ The temperature is set incorrectly.	▶ Turn down the temperature and check after 24 hours.
	→ The appliance is too close to a heat source (oven, radiator, etc).	▶ Move the appliance or the heat source.
	→ The appliance was not correctly installed in the recess.	▶ Check if the appliance was installed correctly and that the door closes properly.
The door seal is defective or needs to be replaced for another reason.	→ The door seal can be replaced. It can be replaced without the need for special tools.	▶ Contact Customer Services (see 9.4 Customer Services) .
The appliance builds up too much ice or condensation.	→ The door seal may have slipped out of its groove.	▶ Check that the door seal is well fitted in the groove.

9.3.2 Features

Defect	Cause	Remedy
You cannot activate the IceMaker.	→ The appliance and therefore the IceMaker are not connected.	▶ Connect the appliance (see the Installation Guide).
The IceMaker is not producing ice cubes.	→ The IceMaker is not on.	▶ Activate the IceMaker.
	→ The drawer of the IceMakers is not connected properly.	▶ Push the drawer in correctly.
	→ The water connection is not open.	▶ Open the water connection.
The internal light does not come on.	→ The appliance is not switched on.	▶ Switch the appliance on.
	→ The door was open for longer than 15 minutes.	▶ Interior lighting turns off automatically after approx. 15 min. with the door open.

Defect	Cause	Remedy
	→ The LED interior light is faulty or the lid is damaged.	▶ Contact customer service (see 9.4 Customer Services) .

9.4 Customer Services

First check if you can fix the error yourself (see 9 Customer help) . If you can't, contact Customer Services.

Please refer to the enclosed "Liebherr-Service" brochure for the address.



WARNING

Unprofessional repair!
Injuries.

- ▶ Have any repairs and action - not expressly specified - on the appliance and mains cable carried out by service personnel only. (see 8 Maintenance)
- ▶ A damaged mains cable may only be replaced by the manufacturer, the manufacturer's Customer Service or a similarly qualified person.
- ▶ In the case of appliances with an IEC connector, the change may be made by the customer.

9.4.1 Contact Customer Services

Make sure you have the following appliance data at the ready:

- Appliance name (model and index)
- Service no. (Service)
- Serial no. (S no.)

- ▶ Look up the appliance information on the display (see Info) .

-or-

- ▶ Referring to appliance info on the nameplate (see 9.5 Model plate) .
- ▶ Note down the appliance information.
- ▶ Notify Customer Services of the following: Give us the appliance data.
- ▶ This will help us to provide you with a faster, more accurate service.
- ▶ Follow any further instructions given by Customer Services.

9.5 Model plate

The model plate is behind the drawers on the inside of the appliance.

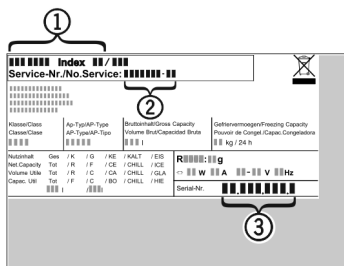

Fig. 55

- (1) Appliance description (3) Serial no.
- (2) Service no.

- ▶ Note the data on the model plate.

10 Shutting down

- ▶ Empty the appliance.
- ▶ Turn off the IceMaker .
- ▶ Turn off the appliance .
- ▶ Remove mains connector.
- ▶ Remove appliance connector if required: Remove and move from left to right at the same time.
- ▶ Clean the appliance (see 8.3 Cleaning the appliance) .
- ▶ Leave the door open to avoid bad smells building up.

11 Disposal

11.1 Preparing appliance for disposal



Liebherr uses batteries in some of its appliances. In the EU, for environmental reasons, legislation obliges the end user to remove these batteries before disposing of old appliances. If your appliance contains batteries, a corresponding notice is attached.

Lamps If you can remove the lamps yourself without destroying them, also remove these before disposal.

- ▶ Take the appliance out of operation.
- ▶ Appliances with batteries: remove the batteries. For description, see **Maintenance** chapter.
- ▶ If possible: remove lamps without destroying them.

11.2 Disposing of the appliance in an environmentally friendly manner



The appliance still contains valuable materials and must be disposed of separately from unsorted municipal waste.



Dispose of batteries separately from the old appliance. To do this, you can return the batteries free of charge to retailers as well as recycling centres and collection centres for recyclable materials.

Lamps Dispose of removed lamps via the respective collection systems.

Disposal



WARNING

Leaking coolant and oil!

Fire. The coolant contained in the appliance is eco-friendly, but also flammable. The oil contained in the appliance is flammable. Escaping coolant and oil can ignite if the concentration is high enough and in contact with an external heat source.

- ▶ Do not damage the pipelines of the coolant circuit and the compressor.
-
- ▶ Transport the appliance without damaging it.
 - ▶ Dispose of batteries, lamps and the appliance according to the above specifications.



home.liebherr.com/fridge-manuals

EN Integrated freezer

Issue date: 20221221

Part number index: 7088285-00

Liebherr-Hausgeräte GmbH
Memminger Straße 77-79
88416 Ochsenhausen
Deutschland