

Operating instructions

Refrigerator

Read the operating instructions before switching on for the first time

Page 28

EN

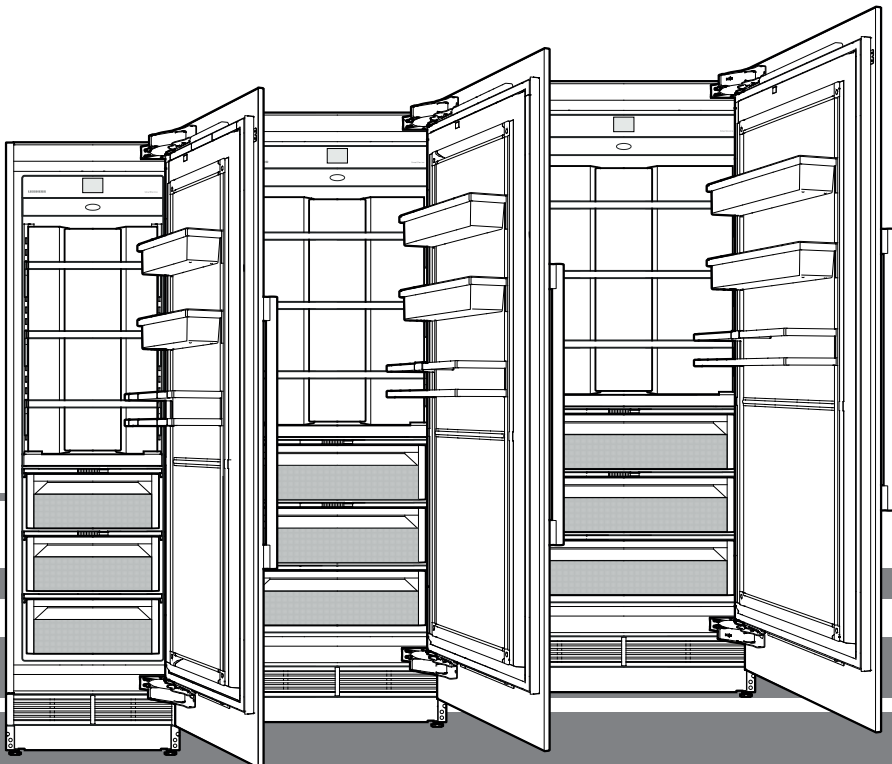

7085 972-00

EKB 92 / EKB 94 / EKB 96

LIEBHERR

Safety instructions and warnings

- **WARNING:** do not seal ventilation openings on the appliance housing or enclosure.
- **WARNING:** only use the mechanical devices or other aids recommended by the manufacturer to help speed up the defrosting process.
- **WARNING:** do not damage the refrigerant circuit.
- **WARNING:** the mains cable must not be damaged while installing the appliance.
- **WARNING:** multi-sockets or distributor strips and other electronic devices (such as halogen transformers) must not be positioned and operated at the rear of appliances.
- **WARNING:** danger of injury through electric shock. There are live parts under the cover. Only have the interior LED light replaced or repaired by customer service staff or trained personnel.
- **WARNING:** ensure that the refrigerant circuit pipes will not be damaged.
- **WARNING:** do not use any electrical devices inside the appliance.
- To prevent injury or damage to the unit, the appliance should be unpacked and set up by four people.
- In the event that the appliance is damaged on delivery, contact the supplier immediately before connecting to the mains.
- To guarantee safe operation, ensure that the appliance is set up and connected as described in these operating instructions.
- Disconnect the appliance from the mains if any fault occurs. Pull out the plug, switch off or remove the fuse.
- When disconnecting the appliance, pull on the plug, not on the cable.
- Any repairs and work on the appliance should only be carried out by the customer service department, as unauthorised work could prove highly dangerous for the user. The same applies to changing the mains power cable.
- Do not allow naked flames or ignition sources to enter the appliance. When transporting and cleaning the appliance ensure that the refrigerant circuit is not damaged. In the event of damage, make sure that there are no ignition sources nearby and keep the room well ventilated.
- Do not stand on the plinth, drawers or doors or use them to support anything else.
- This appliance can be used by children of 8 years old and over, and also by persons with restricted physical, sensory or mental capacity or lack of experience and knowledge if they are supervised or have been instructed on the safe use of the appliance and understand the resulting risks. Children must not be allowed to play with the appliance. Cleaning and user maintenance must not be carried out by children without supervision.
- Avoid prolonged skin contact with cold surfaces or chilled/frozen food. This could cause pain, numbness and frostbite. In the case of prolonged skin contact, protective measures should be taken, e.g. gloves should be worn.
- Do not consume food which has been stored for too long, as it could cause food poisoning.
- Do not store any explosive substances, such as aerosol containers with flammable propellant gas, inside the appliance.
- Do not store explosives or sprays using flammable propellants such as butane, propane, pentane, etc. in the appliance. Electrical components might cause leaking gas to ignite. You may identify such sprays by the printed contents or a flame symbol.
- If you have a lockable appliance, do not keep the key near the appliance or within reach of children.
- The appliance is designed for use in enclosed areas. Do not operate the appliance outdoors or in areas where it is exposed to splash water or damp conditions.
- The LED lights illuminate the interior of the appliance. They are not suitable for lighting a room.

Content

Safety instructions and warnings	28
Content.....	29
Disposal notes.....	29
EPREL database	29
Range of appliance use.....	30
Description of the appliance.....	30
Control panel.....	31
Switching the appliance on	31
Changing language and temperature unit.....	31
Main menu.....	32
Setting the refrigerator compartment temperature.....	32
Changing the BioFresh-Plus compartment temperature	33
SuperCool	33
PartyMode.....	34
HolidayMode.....	34
SabbathMode.....	35
Switching the appliance off	35
Maintenance message.....	36
Maintenance confirmation.....	36
Setup menu	37
SmartDeviceBox (not supplied in all countries).....	39
Description of the SmartDevice display	39
Alarm messages	40
Interior light.....	40
Equipment	41
Water dispenser	41
BioFresh compartment.....	42
BioFresh-Plus compartment	42
Cleaning	43
Maintenance menu.....	44
Maintenance.....	45
Additional functions.....	48
Saving energy	52
Malfunctions.....	52
Shutting your appliance down.....	52



DANGER!

Danger indicates a hazard which will cause serious injury or death if precautions are not followed.



WARNING!

Warning indicates a potentially hazardous situation which, if not avoided, could result in death or serious injury.



CAUTION!

Caution indicates a potentially hazardous situation which, if not avoided, may result in minor or moderate injury.

IMPORTANT

This indicates information that is especially relevant to a problem-free installation and operation.

Disposal notes



The appliance contains reusable materials and should be disposed of properly - not simply with unsorted household refuse. Appliances which are no longer needed must be disposed of in a professional and appropriate way, in accordance with the current local regulations and laws.

When disposing of the appliance, ensure that the refrigerant circuit is not damaged to prevent uncontrolled escape of the refrigerant it contains (data on type plate) and oil.

- Disable the appliance.
- Pull out the mains plug.
- Cut through the connection cable.



WARNING

Danger of suffocation due to packing material and plastic film! Do not allow children to play with packaging material. Take the packaging material to an official collection point.



A sticker to this effect may be applied to the rear of the appliance. It refers to the foampadded panels in the door and/or the housing. This is only relevant for recycling. Do not remove the sticker.

Climate rating

The climate rating indicates the room temperature at which the appliance may be operated in order to achieve full refrigeration performance.

The climate rating is indicated on the type plate.

The position of the type plate is shown in the section entitled **Description of the appliance**.

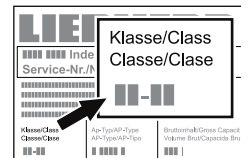

Climate rating	Room temperature
SN	+10°C to +32°C
N	+16°C to +32°C
ST	+16°C to +38°C
T	+16°C to +43°C
SN-ST	+10°C to +38°C
SN-T	+10°C to +43°C

Do not operate the appliance outside the specified room temperature range.

EPREL database:

As from 1 March 2021, information about energy labelling and ecodesign requirements will be available in the European product database (EPREL). You can access the product database using the following link: <https://eprel.ec.europa.eu/>. You will be asked to enter the model identifier. You will find the model identifier on the type plate.

IMPORTANT

All types and models are subject to continuous improvement. The manufacturer reserves the right to make modifications to the shape, equipment and technology.

Range of appliance use

The appliance is suitable solely for cooling food in a domestic environment or similar. This includes, for example, use

- in staff kitchenettes, bed and breakfast establishments,
- by guests in cottages, hotels, motels and other forms of accommodation,
- in catering and similar services in the wholesale trade.

Use the appliance solely as is customary within a domestic environment. All other types of use are inadmissible. The appliance is not suitable for storing and cooling medicines, blood plasma, laboratory preparations or similar substances and products covered by the 2007/47/EC Medical Devices Directive. Any misuse of the appliance may result in damage to or spoilage of stored goods. Furthermore, the appliance is not suitable for operation in potentially explosive atmospheres.

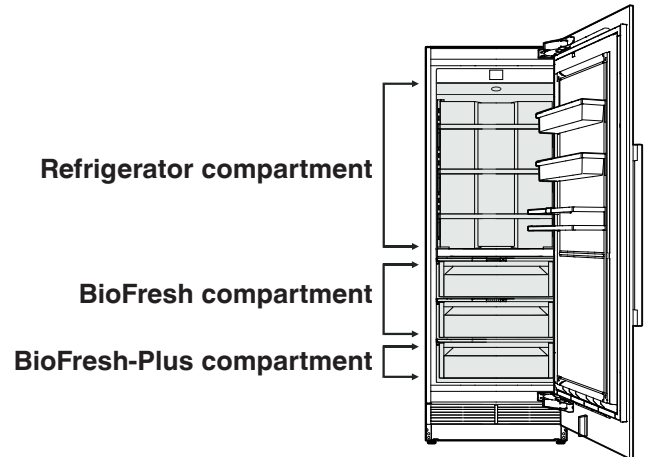

Description of the appliance

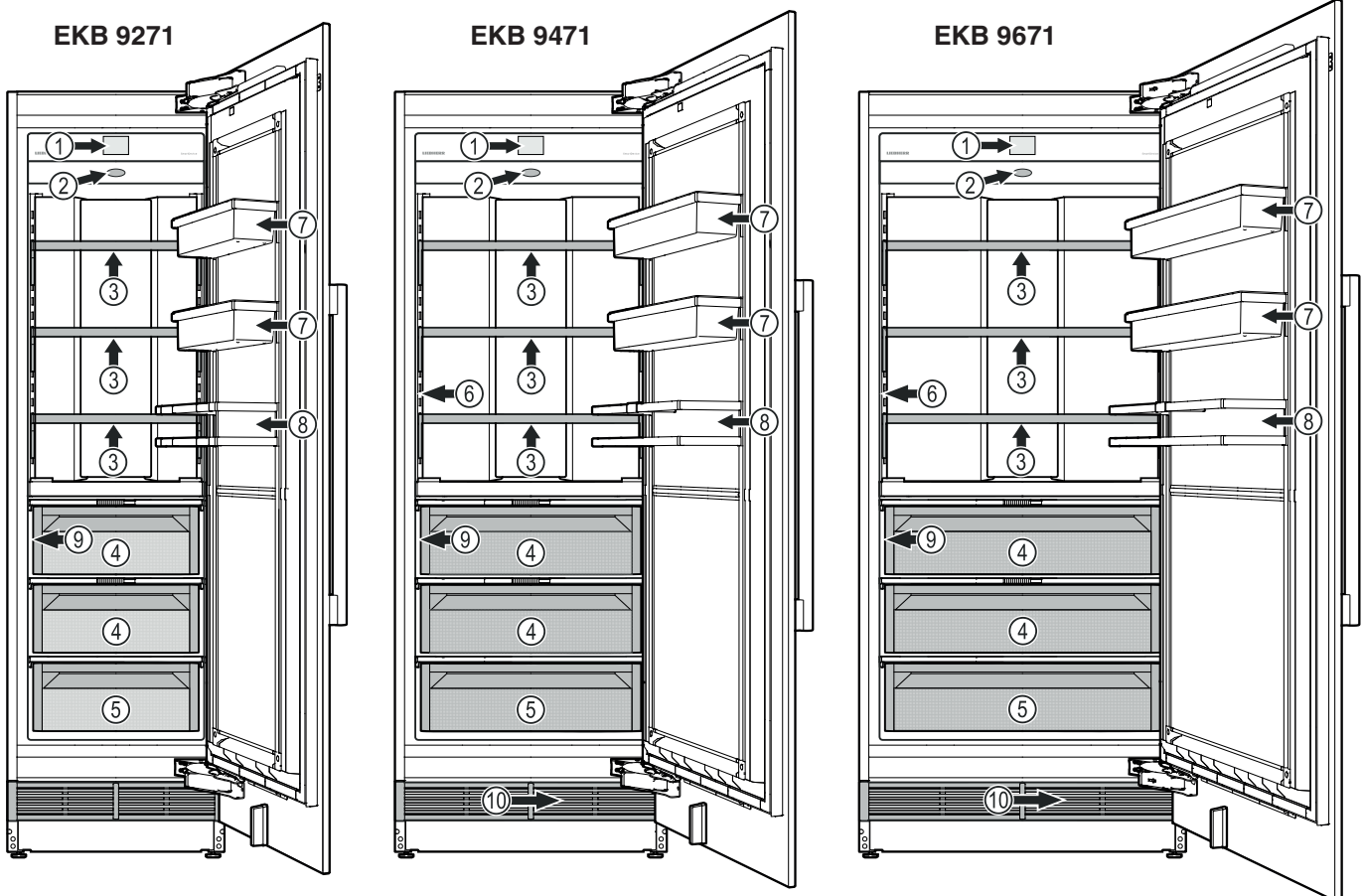

- | | |
|---|---|
| <ul style="list-style-type: none"> (1) Control panel (2) Air filter (3) Adjustable shelves (max. 20 kg) (4) BioFresh drawers. Temperature approx. 0°C. For storing dry or wrapped food at low humidity setting, for storing unwrapped food with a high moisture content at high humidity setting. | <ul style="list-style-type: none"> (5) BioFresh-Plus drawer. For storing dry or wrapped food at 0°C, for seafood at -2°C. (6) Water dispenser (7) Adjustable door rack (8) Bottle rack (9) Type plate (behind the drawer on the left-hand side) (10) Water filter (behind the ventilation grille) |
|---|---|

EKB 92.. (max. 20 kg)
 EKB 94.. (max. 25 kg)
 EKB 96.. (max. 30 kg)

Control panel

Three different actions to operate the control panel.

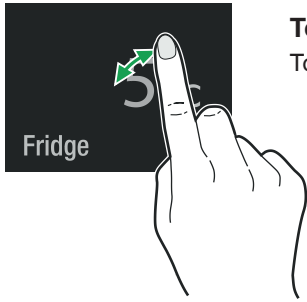

Touch
Touch to activate functions.

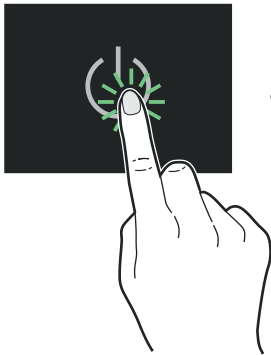

Press
Press for approx. 2 seconds to activate functions.

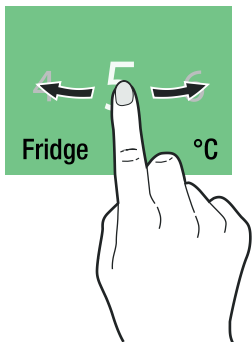

Slide
Slide to right or left to navigate in the menu or to search for values.

Switching the appliance on

Touch

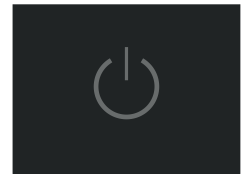

Slide to your language and touch



Available languages:

- German
- Portuguese (Brazil)
- French
- Spanish
- Italian
- English (GB)
- English (US)
- Chinese
- Russian

Slide to the desired temperature unit and touch

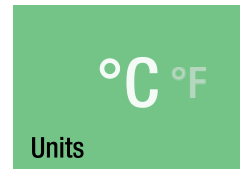

Touch to confirm or slide to the right to change the previous settings again.

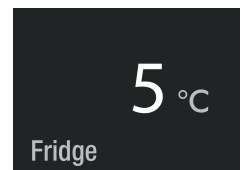
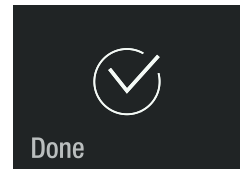





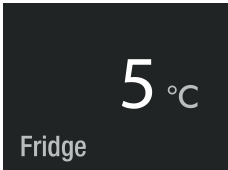
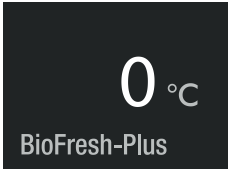

Changing language and temperature unit

For future changes of language and temperature unit, the appliance must be switched off and on again (customer settings will not be deleted).

Main menu

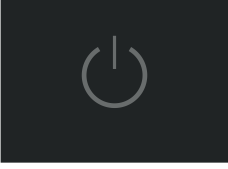
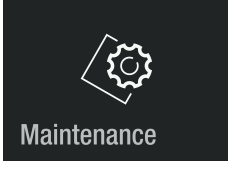
Navigation through the main menu. The following functions are available.

 <p>Fridge</p>	<p>Refrigerator compartment temperature display and temperature setting.</p>
 <p>BioFresh-Plus</p>	<p>BioFresh-Plus compartment temperature display and temperature setting.</p>
 <p>SuperCool</p>	<p>For maximum cooling with time limit and automatic return to normal operating mode.</p>
 <p>PartyMode</p>	<p>For permanent maximum cooling.</p>
 <p>HolidayMode</p>	<p>Switches the appliance to an energy-saving operating mode; the temperature in the refrigerator compartment is increased to 15°C.</p>
 <p>SabbathMode</p>	<p>Appliance operating mode for Sabbath and holidays. Complies with STAR-K Kosher Certification.</p>
	<p>Switching the appliance on or off.</p>
 <p>Maintenance</p>	<p>Describes how to change the filters and clean the water dispenser and dust filter.</p>
 <p>Setup</p>	<p>Allows the adjustment of display brightness and includes the appliance information (service number, model name, serial number).</p>

Setting the refrigerator compartment temperature

Standard setting is 3°C.

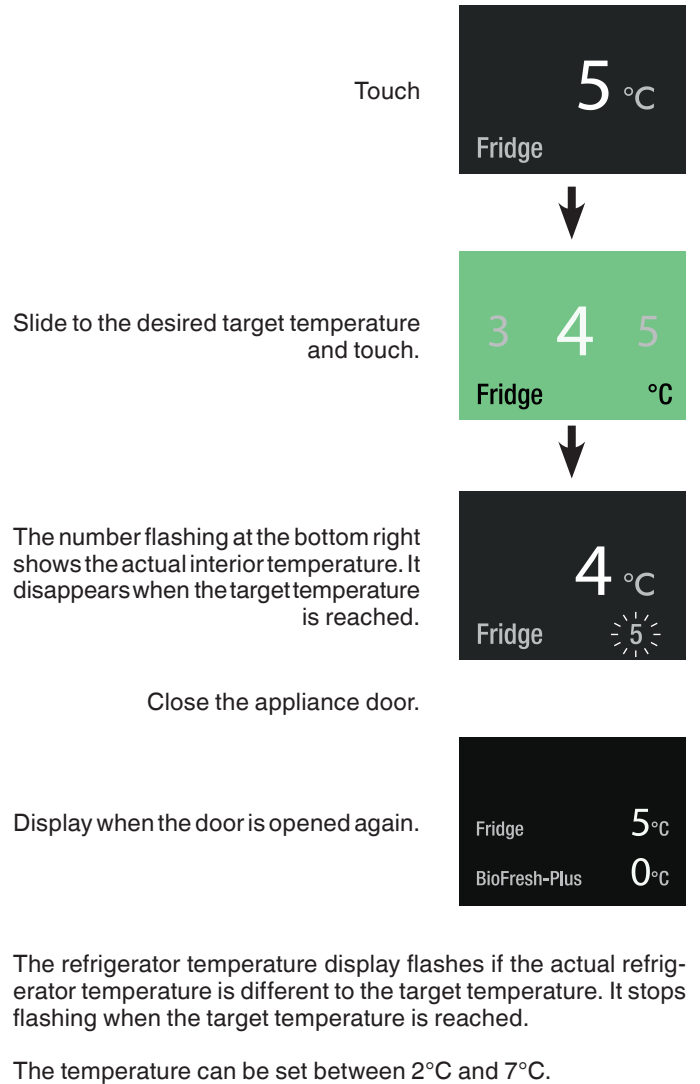

Changing the BioFresh-Plus compartment temperature

Standard setting is 0°C.

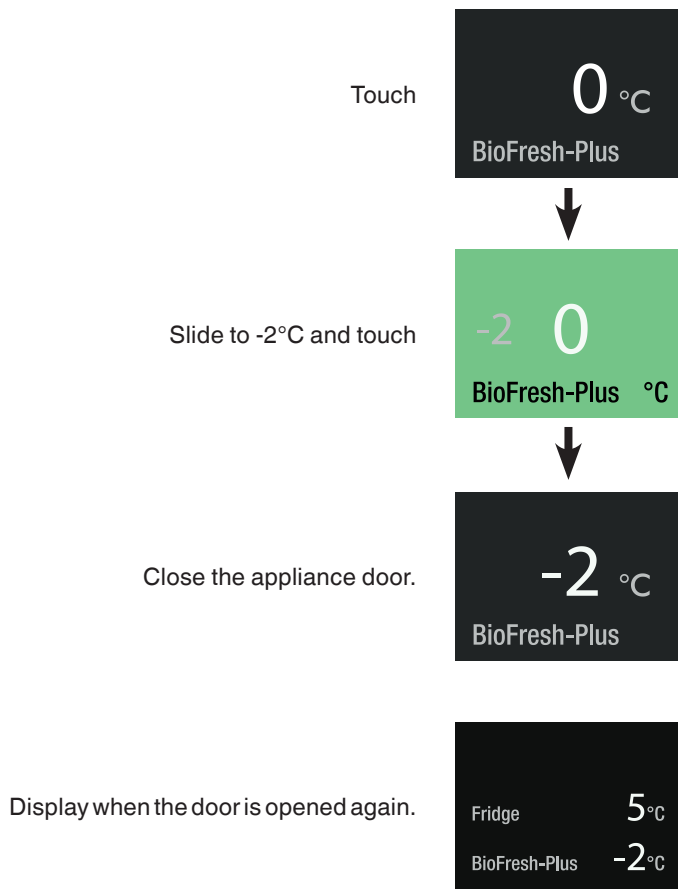

SuperCool

Activate SuperCool if you wish to cool large quantities of food rapidly. The set temperature is 2°C.

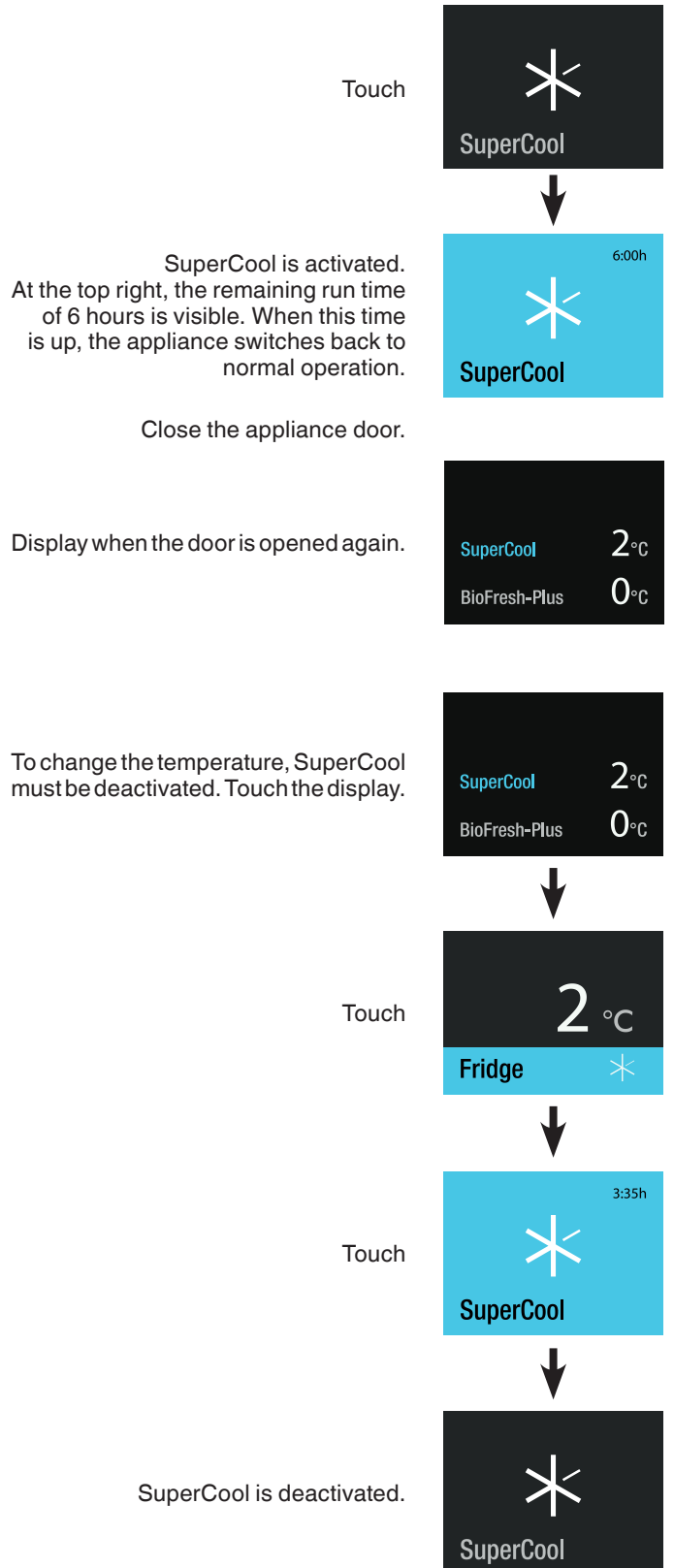

PartyMode

When a large amount of cold food or beverages is needed: place all the food and beverages in the appliance one day before and activate PartyMode.



PartyMode is activated
It must be deactivated manually.
Close the appliance door.



Display when the door is opened again.
Refrigerator temperature display flashes.

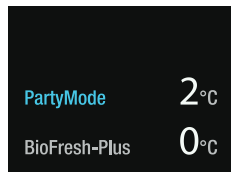

To change the temperature, PartyMode must be deactivated. Touch the display.

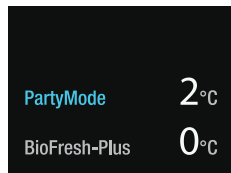

Touch

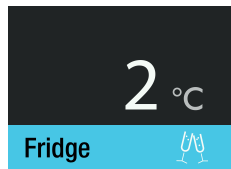

Touch



Refer to chapter
Setting the refrigerator compartment temperature.

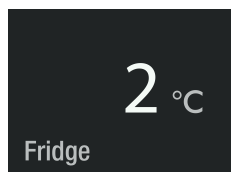

HolidayMode

In the case of lengthy periods of absence, use up any food which is in the refrigerator and activate HolidayMode. This ensures that no unpleasant odours develop inside the appliance, even if the appliance door is closed. (The temperature in the refrigerator compartment is increased to 15°C.)

Touch

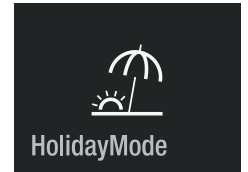

HolidayMode is activated.
Close the appliance door.



Display when the door is opened again.

The display shows the actual temperature in the refrigerator compartment.

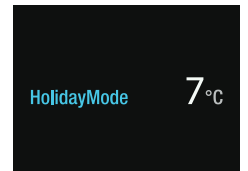

If you want to deactivate HolidayMode, touch the display.

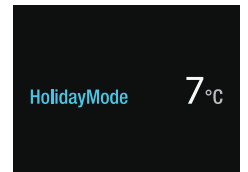

Touch

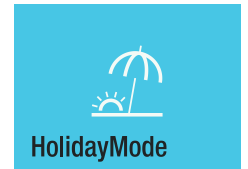

HolidayMode is deactivated.



SabbathMode

When SabbathMode is active, some electronic functions are switched off to comply with STAR-K Kosher Certification.

- The lighting remains off.
- The cooling fan remains in its actual state: if it is on, it remains on; if it is off, it remains off.
- There is no door alarm.
- There is no temperature alarm.
- Defrost cycles are independent of the number of times and length of door openings.
- The appliance will return to SabbathMode after a power failure.

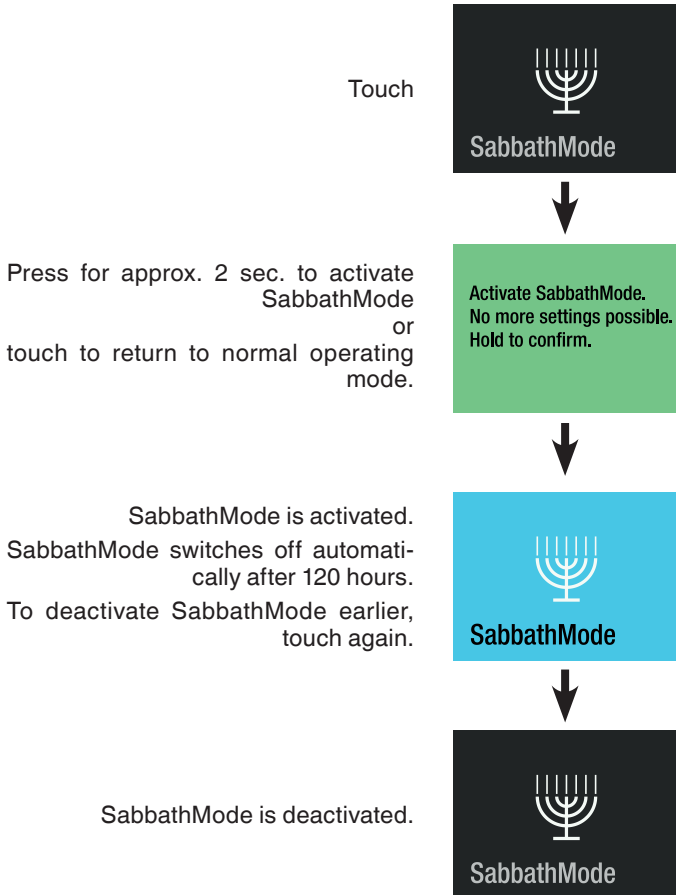

Switching the appliance off

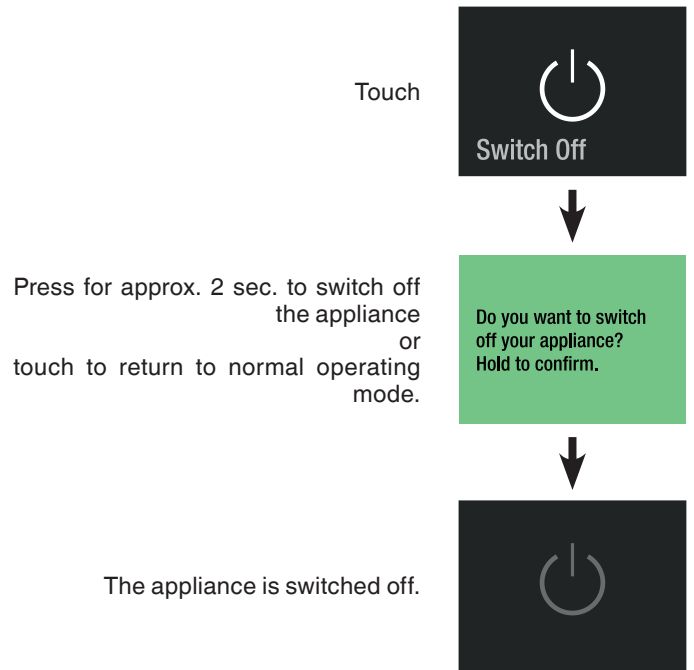

Maintenance message

In regular intervals of operation of the appliance, the maintenance message comes on (6 months). Filters need to be changed. The water dispenser (if existing) needs to be flushed. The dust filter needs to be cleaned.

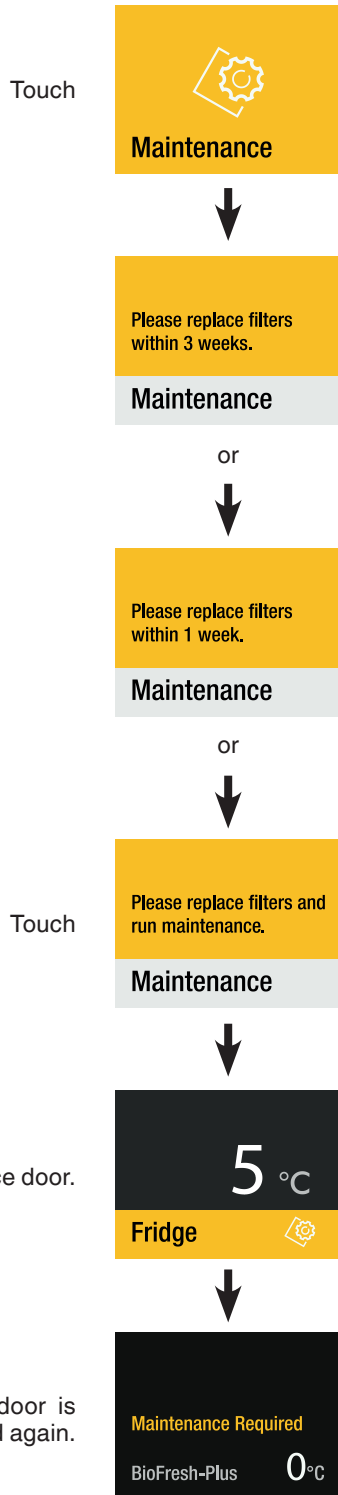

Obtain water filter and air filter from your dealer and complete the maintenance procedure.

Maintenance confirmation

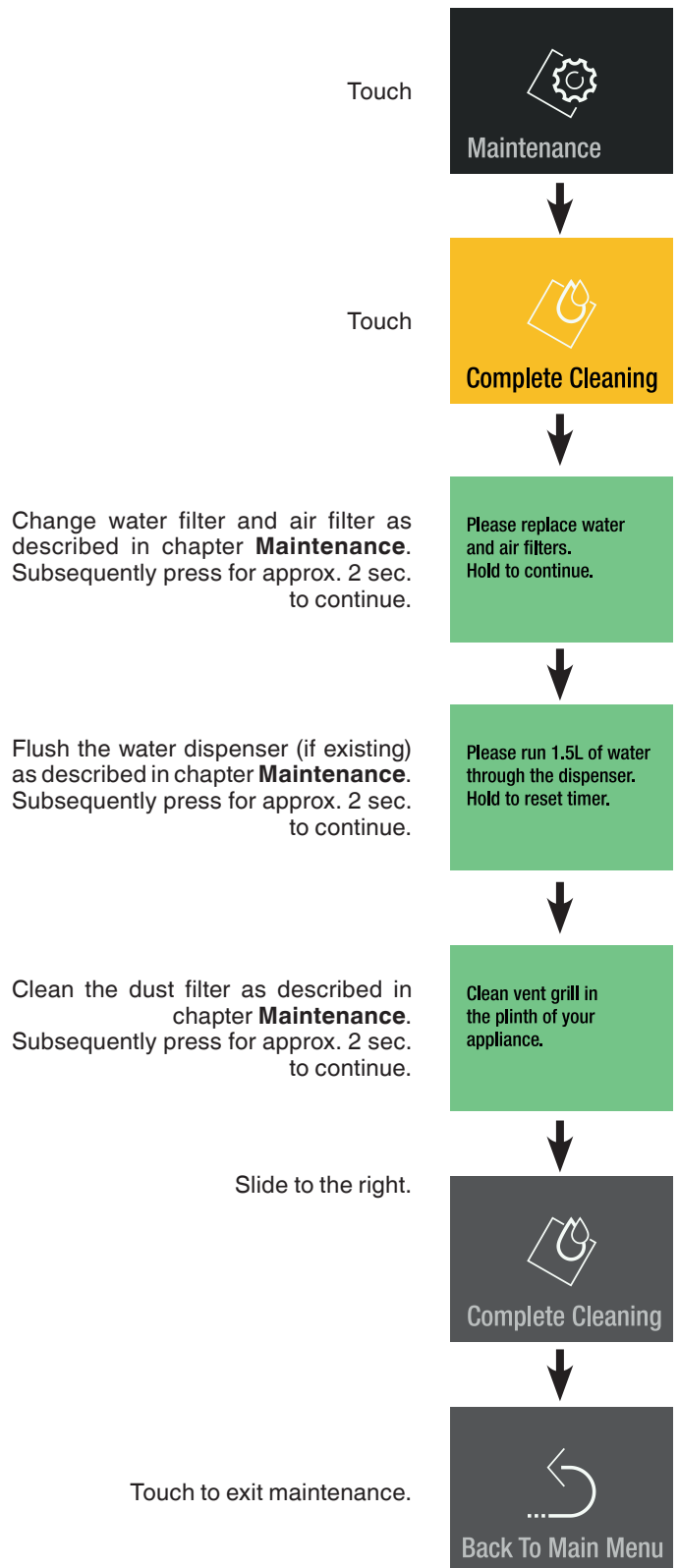

Setup menu

Includes the adjustment for display brightness, language, units, activation of the SmartDeviceBox and the appliance information.

Display brightness

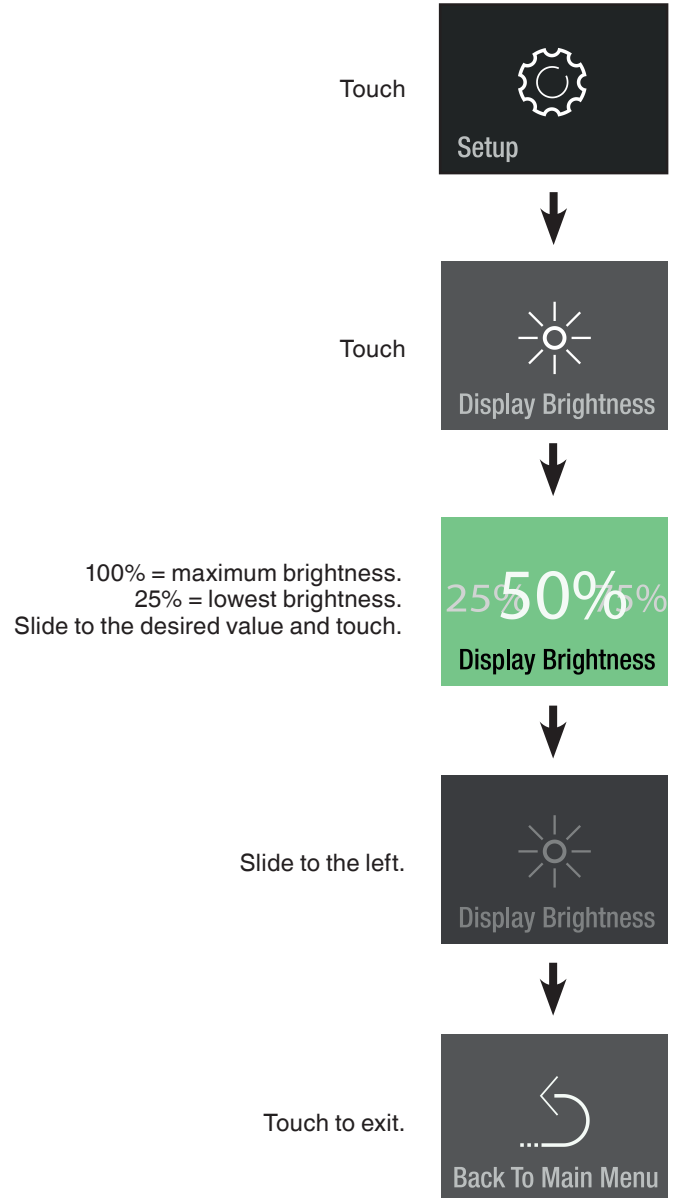
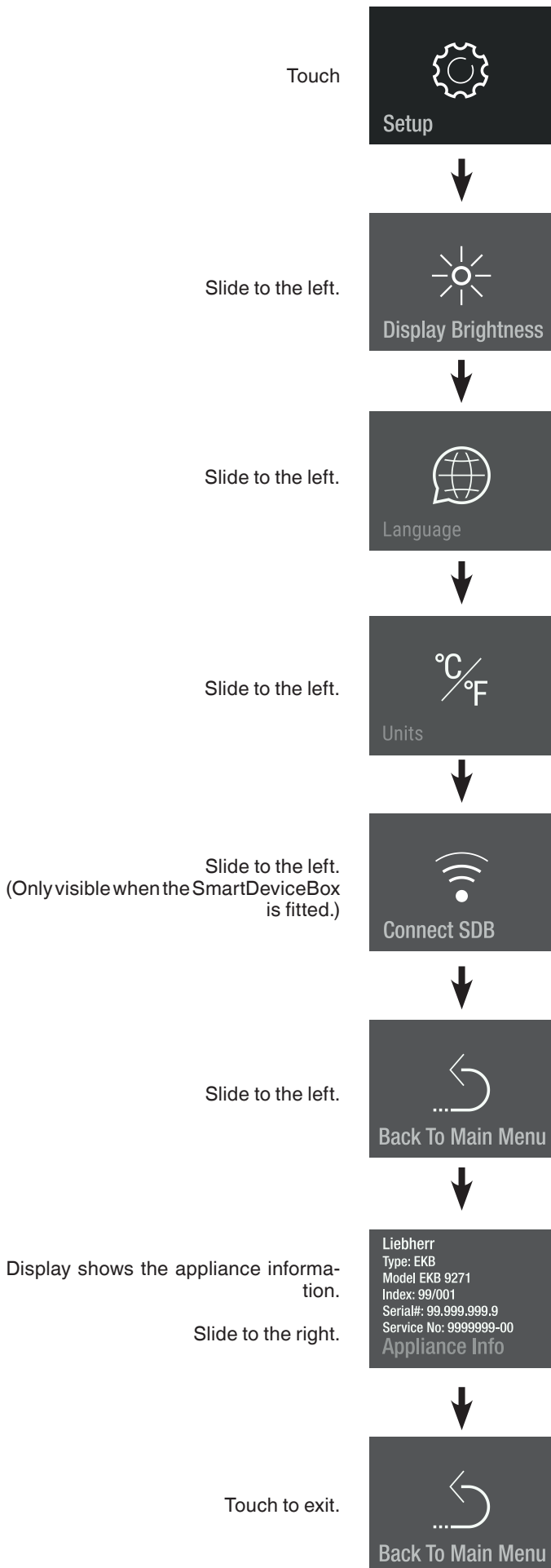

Language

Touch



Slide to your language and touch



Available languages:

- German
- Portuguese (Brazil)
- French
- Spanish
- Italian
- English (GB)
- English (US)
- Chinese
- Russian

Slide twice to the left.

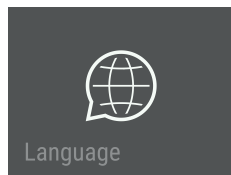

Touch to exit.

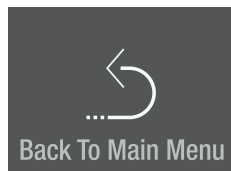

Units

Touch

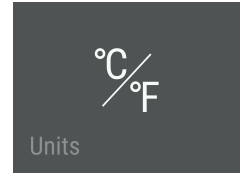

Slide to the desired temperature unit and touch

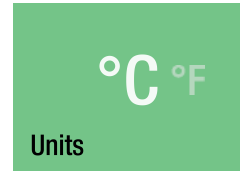

Slide to the left.

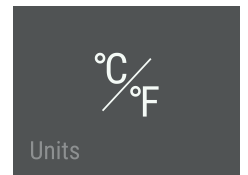

Touch to exit.

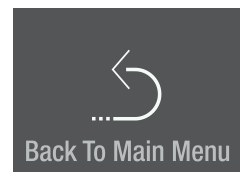

SmartDeviceBox (not supplied in all countries)

The appliance is ready for integration into a smart home system and for extended services.

You will find more information about availability and prerequisites and the individual options on the website smartdevice.liebherr.com.



Download the "SmartDevice" app to your mobile device.

Start the app on your mobile device and follow the instructions.

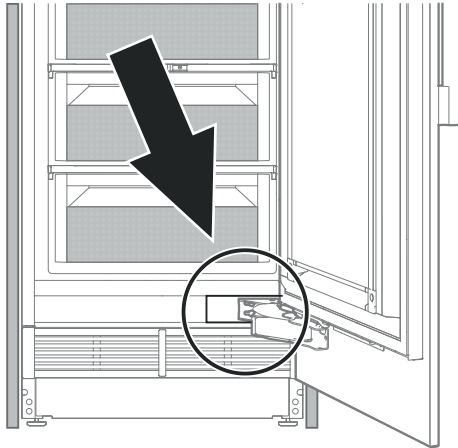

SmartDevice functions are not available in all countries.

Description of the SmartDevice display

SmartDeviceBox is inserted.

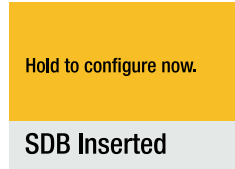

Display to start the WLAN connection.



The symbol flashes.
Connection to WLAN is in progress.

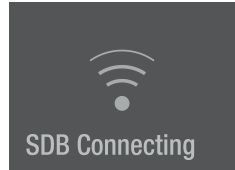

The router credentials are displayed.

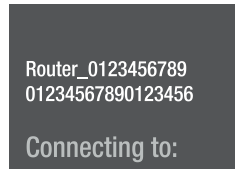

Appliance is connected to WLAN.



Connection reset.



This message informs you of any router or Internet problems.

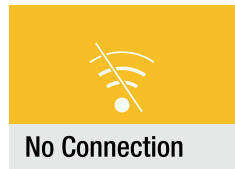

Alarm messages

Door open alarm

Door has been left open for longer than 180 seconds.

Action
Close the appliance door.



Electronic fault alarm

Electronic fault.
Touch

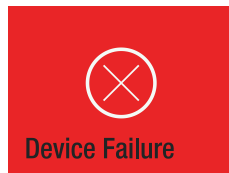

Action
Contact the customer service department, stating the failure code displayed.

Touch

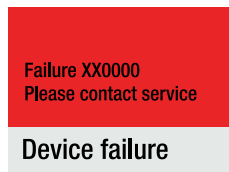

Touch

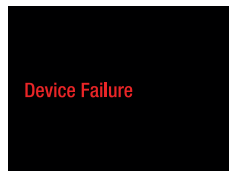

Press for approx. 2 seconds to read failure code again.



Connection failure

Touch



Action
Contact the customer service department, stating the failure code displayed.

Touch



The connection is disabled.
There is no need to move any items to another appliance.

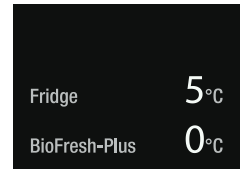

The menu will continue to show the "Connection failure" error until it has been rectified by the customer service team.



Interior light

The interior light is located at the left and right in the refrigerator compartment and at the top of the BioFresh compartment. It turns on when the appliance door is opened.

The light intensity of the LED light corresponds to laser class 1/1M.

IMPORTANT

The light cover may only be removed by customer service staff.



Risk of eye damage.

If the cover is removed, do not look directly at the light through optical lenses from a close distance.

Lighting	
Class ¹	Light source
This product contains a light source that meets energy efficiency rating G	LED
¹ The appliance may contain light sources with different energy efficiency classes. The lowest energy efficiency class is indicated.	

Equipment

You can position the shelves and door racks at different heights as required.



Risk of injury and damage.

Do not attempt to adjust a shelf or door rack with food on it.

Only adjust an empty shelf or door rack.

Repositioning the shelves

Removing

Lift the shelf up and remove.

Installing

Insert the hooks of the shelf into the openings of the clip-in strip at the desired height and push down.

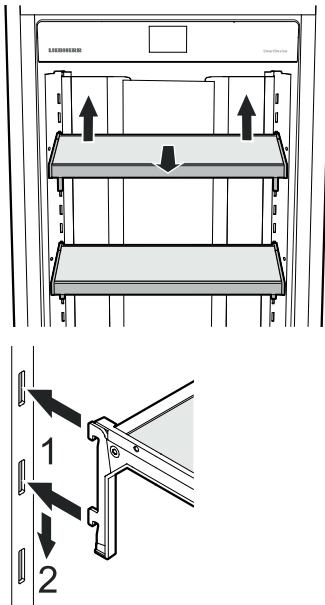

Repositioning the door racks

Removing

Lift the rack up and remove.

Installing

Insert the hooks of the rack into the openings of the clip-in strip at the desired height and push down.

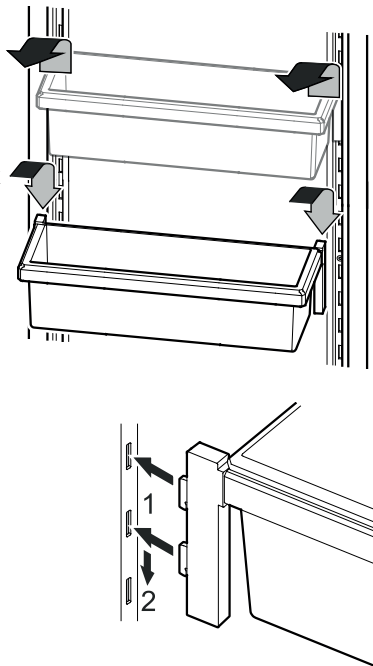

Bottle holder

You can protect the bottles from falling over when the door is opened and closed.

Move the bottle holder to the desired position. Always hold at the front when moving.

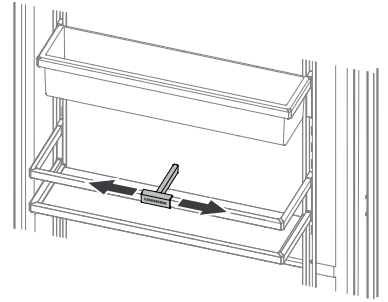

Bottle tray

The tray above the BioFresh drawers can be used for storing bottles horizontally.

Remove glass plate.

IMPORTANT

When storing tall bottles (higher than 230 mm), the bottle rack must be relocated to a higher position to avoid collision.

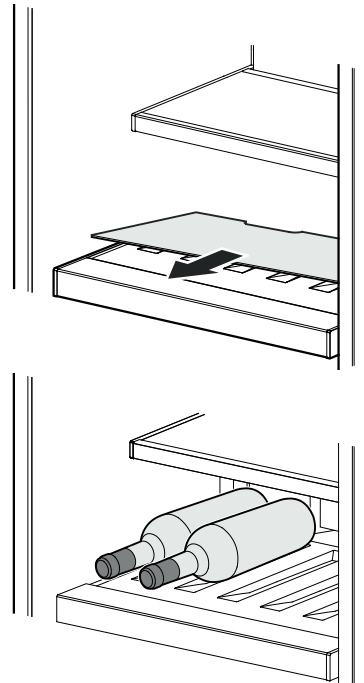

Water dispenser

(models EKB 9471, EKB 9671 only)

Press a drinking glass against the bottom part of the dispenser. The top part moves out and the water flows into the glass.

(max. time 2 min → waiting time before reuse 4 min)

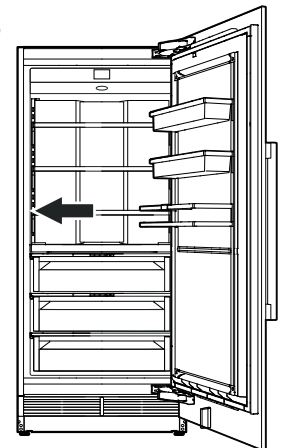
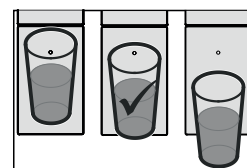
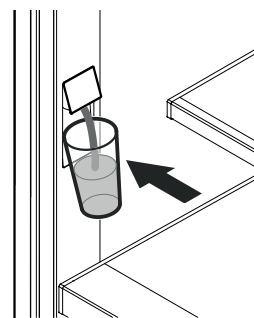

Note

The water temperature is determined by the appliance setting and the water intake temperature.

BioFresh compartment

The BioFresh compartment enables you to keep food for up to 3 times longer than in normal refrigerators.

The constant temperature of just above 0°C and the adjustable humidity provide the ideal storage conditions for different types of food.

The BioFresh compartment complies with the requirements for a cold-storage compartment pursuant to EN 62552:2021.



Slide control to right

(dry setting)

This setting is suitable for dry or wrapped food like dairy products, meat, fish, cold cuts.



Slide control to left

(humid setting)

This setting is suitable for storing unwrapped food with a high moisture content such as salad, vegetables and fruit.

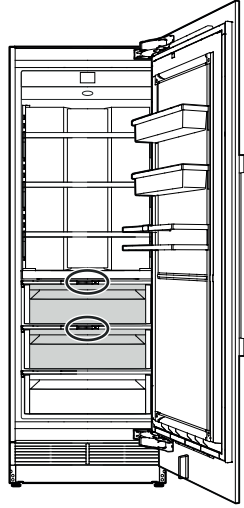

Notes

- The humidity in the compartment depends on the moisture content of the food and the frequency with which a drawer is opened.
- The fresher the product and the higher its quality, the longer the storage life.
- Unwrapped animal and vegetable foods should be stored separately in the drawers. If there is not enough space for them to be stored separately, make sure that they are wrapped. Do not allow different types of meat to come into contact with one another but keep them packaged separately so as to avoid premature bacterial spoilage.
- The following products should not be stored in the BioFresh compartment: hard cheese, potatoes, cold-sensitive vegetables such as cucumber, aubergines, avocados, semi-ripe tomatoes, courgettes and all cold-sensitive tropical fruits such as pineapples, bananas, grapefruit, melons, mangos, papayas, etc.

BioFresh-Plus compartment

Set the temperature of the BioFresh-Plus compartment in accordance with the type of stored food. See chapter "Changing the BioFresh-Plus compartment temperature".

Set to 0°C (factory setting) for storing meat, sausage or dairy products. These storing conditions are the same as in the BioFresh compartment at dry setting.

Set to -2°C for storing fish or seafood. Storage time is 3 days at the most.

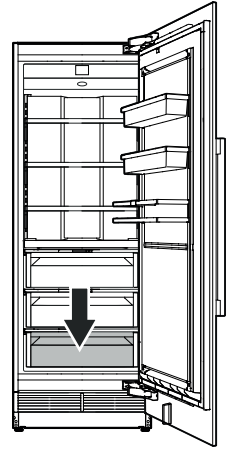

Storage times (days) for food in the BioFresh compartment at dry setting or in the BioFresh-Plus compartment at 0°C temperature setting

poultry.....	up to	5
milk (fresh).....	up to	7
pork, beef, game, sausage, cold cuts.....	up to	7
butter, cheese.....	up to	30

Storage times (days) for food in the BioFresh compartment at humid setting

green onions, mushrooms, spinach	up to	7
lettuce, peas	up to	10
asparagus, broccoli, Chinese cabbage, curly kale, kohlrabi, radishes	up to	14
cauliflower, fennel, lamb's lettuce, radicchio, iceberg lettuce, endives	up to	21
brussels sprouts, celery, chicory, herbs.....	up to	30
leeks, savoy cabbage.....	up to	60
carrots	up to	150
cabbage, garlic.....	up to	180
raspberries, strawberries.....	up to	5
blackberries, figs (fresh).....	up to	7
apricots, bilberries, cherries	up to	14
black and red currants, gooseberries, plums, rhubarb	up to	21
peaches.....	up to	30
dates (fresh)	up to	60
grapes, quinces.....	up to	90
kiwi fruit, pears.....	up to	120
apples.....	up to	180

Cleaning

WARNING!

- To prevent possible injury due to an electric shock, be sure to disconnect the mains cable or switch off the fuse before cleaning the appliance.
- To avoid injury or damage, do not use steam cleaning equipment to clean the appliance.
- To avoid short-circuits, ensure no cleaning water penetrates into the electrical components when cleaning the appliance. Do not use a sponge or cloth that is overly wet.

- Remove the food from the appliance and store in a cool place.
- Remove the shelves and door racks. Refer to chapter **Equipment**.

- Remove the BioFresh drawers.

Pull the drawer straight out, grip at the back and lift out.

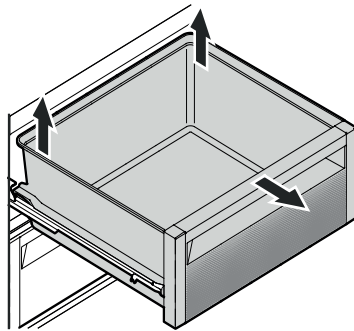

- Clean the inside of the appliance and equipment parts with lukewarm water and a little detergent.

IMPORTANT

Do not use abrasive or scouring pads or sponges.
Do not use concentrated cleaning agents. Never use abrasive or acid-based cleaners or chemical solvents.

- Clean the pull-out rails with a slightly dampened cloth only.

IMPORTANT

No cleaning water must be allowed to get into the pull-out rail guides.

- Dry all parts well with a cloth.
- Do not damage or remove the type plate on the inside of the appliance. It is very important for servicing purposes.

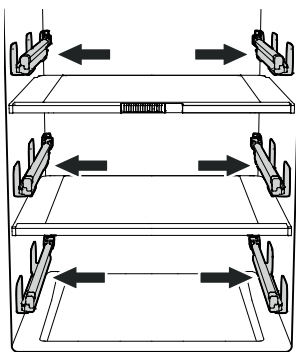

- Insert the BioFresh drawers.

Extend the pull-out rails as far as they will go. Place the drawer on the rails and slide it right in.

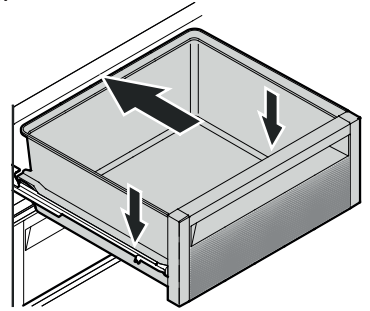

- Install all equipment parts and replace the food in the appliance. Refer to chapter **Equipment**.
- Switch the appliance on.

Maintenance menu

Maintenance can be carried out independently of the specified regular intervals. The maintenance menu includes the following steps.



Complete cleaning
For complete maintenance of the appliance.



Please replace water and air filters.
Hold to continue.

Please run 1.5L of water through the dispenser.
Hold to reset timer.

Clean vent grill in the plinth of your appliance.

Clean dispenser
To interrupt the water supply for cleaning the dispenser outlet.



Please clean water dispenser.
Hold to activate water dispenser.

New water filter
To flush and reset maintenance timer.



Please replace water filter.
Hold To continue.

Please run 1.5L of water through the dispenser.
Hold to reset timer.

New air filter
To reset maintenance timer.

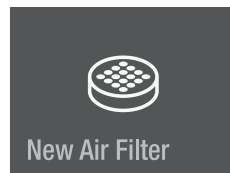

Please replace air filter.
Hold to reset timer.

Clean rinse
To flush the water dispenser when the dispenser has not been used for a longer period of time.

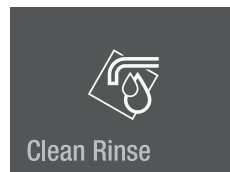

Please run 1.5L of water through the dispenser.

To return to the main menu.

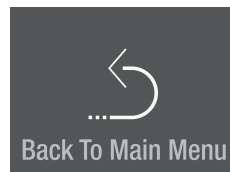

Maintenance

Maintenance

New water filter

(models EKB 9471, EKB 9671 only)

The inserted water filter absorbs deposits in the water and reduces the taste of chlorine.

IMPORTANT

To avoid reduction of the water flow rate of the dispenser, the water filter should be changed at least at the indicated maintenance intervals.

If noticeable water flow reduction occurs, the water filter should be changed sooner.

Note

It is not necessary to switch off the water supply when removing or inserting the filter.

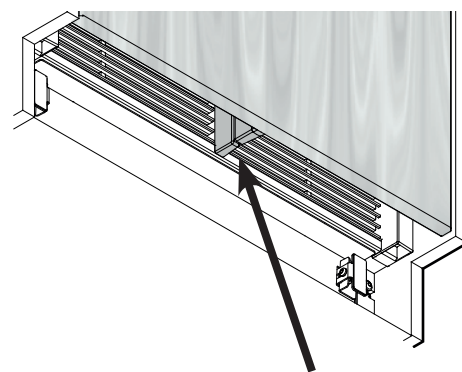
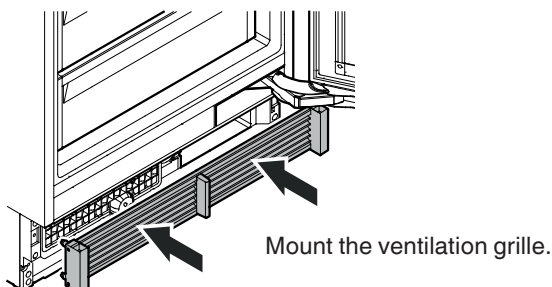
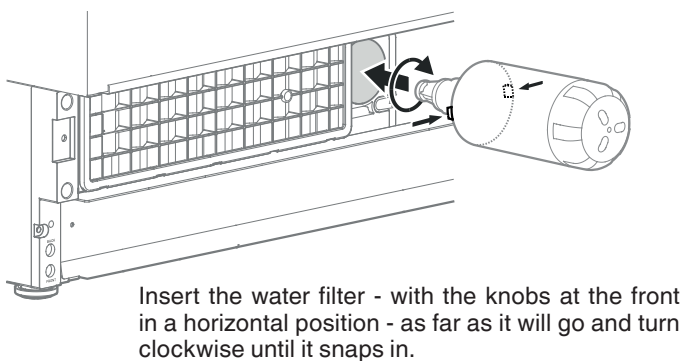
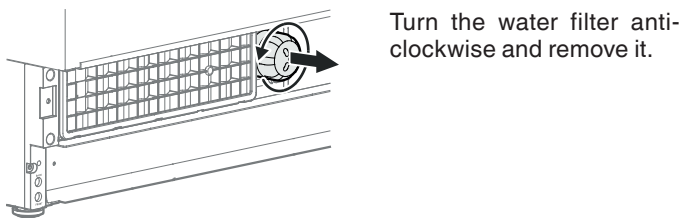
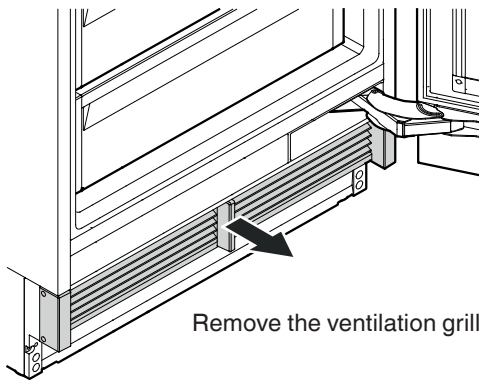

IMPORTANT

There will be a gap if the ventilation grille is fitted incorrectly.

Touch



Press for approx. 2 sec.

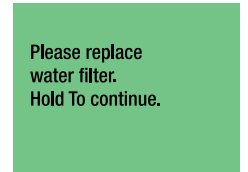

Press for approx. 2 sec.

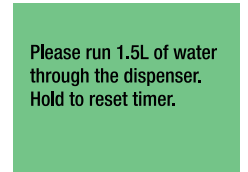

Flush approx. 1.5 l of water through the dispenser and discard.

The timer for water filter change is reset.

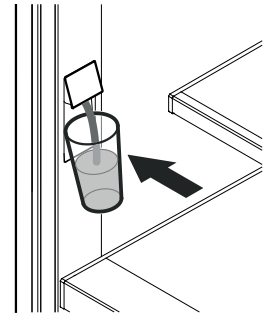

Slide 3 times to the left.



Touch to exit the menu.

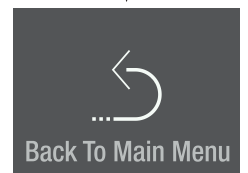

Dispenser cleaning

(models EKB 9471, EKB 9671 only)

The dispenser outlet and the surrounding area can be cleaned without disconnecting the appliance from the electrical power supply.



The water supply is stopped now.

- Press in the bottom part of the dispenser so that the top part moves out.
- Clean the water outlet and the surrounding area.
- Release the bottom part of the dispenser.

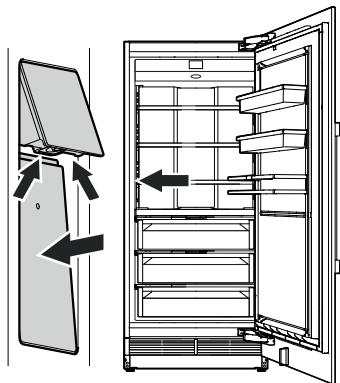

Press for approx. 2 sec.

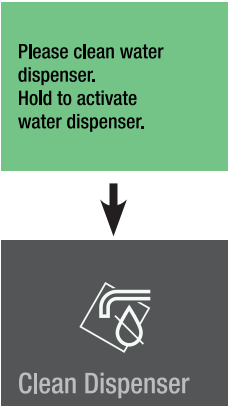

The water dispenser is ready for use again.

If the water flow is no longer even, the aerator must be replaced (see contact details on the back of this manual).

New air filter

The air filter absorbs odours from the appliance interior. It should be changed at least at the indicated maintenance intervals.

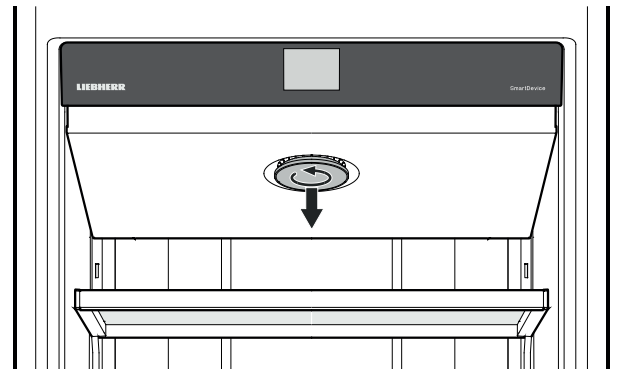
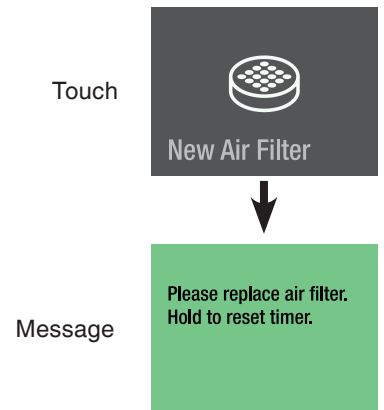

Turn the cover anticlockwise and remove it.

Turn the air filter anticlockwise and remove it.

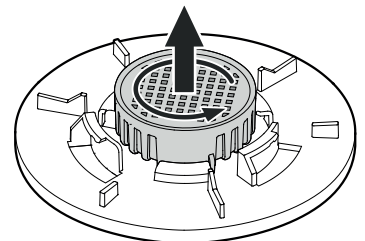

Insert the new air filter and turn clockwise until it snaps in.

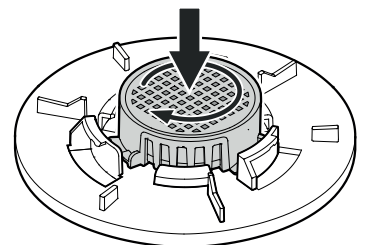

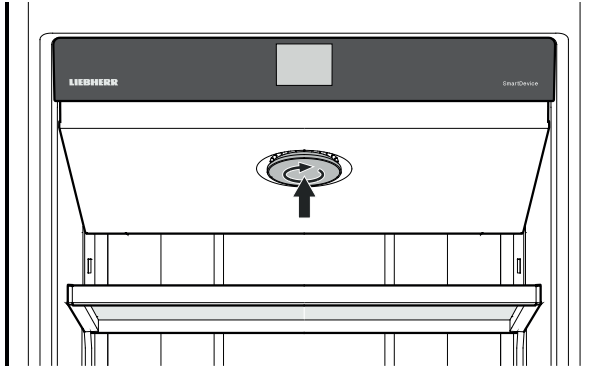

Insert the cover and turn clockwise until it snaps in.

Press for approx. 2 sec.
The maintenance timer for air filter
change is reset.



Slide twice to the left.



Touch to exit the menu.

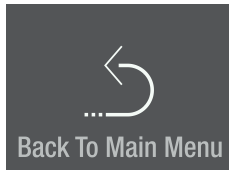

Clean rinse
(models EKB 9471, EKB 9671 only)

When the water dispenser has not been used for one week or more, flush the pipeline.

Touch



Message

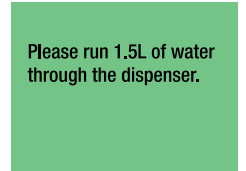

Flush approx. 1.5 l of water through
the dispenser and discard.

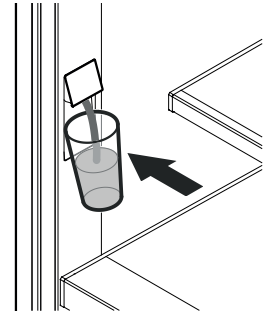

Press for approx. 2 sec.

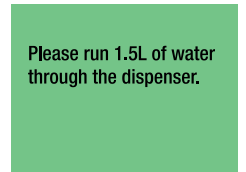

Slide to the left.

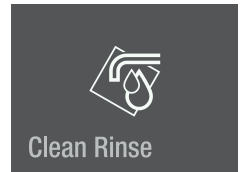

Touch to exit the menu.

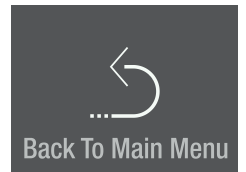

Cleaning the dust filter

Clean the dust filter in the plinth area at least at the indicated maintenance intervals.

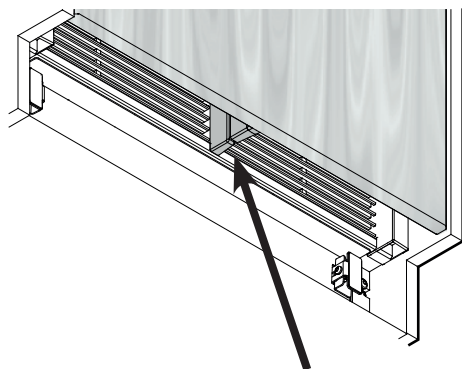
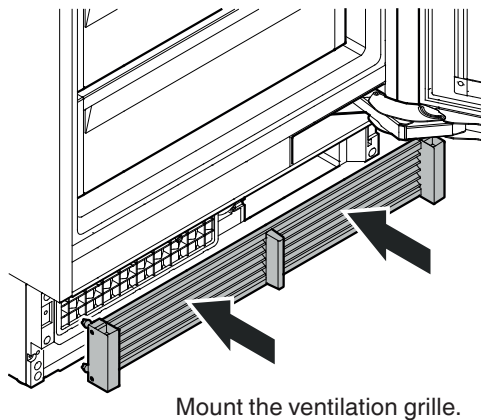
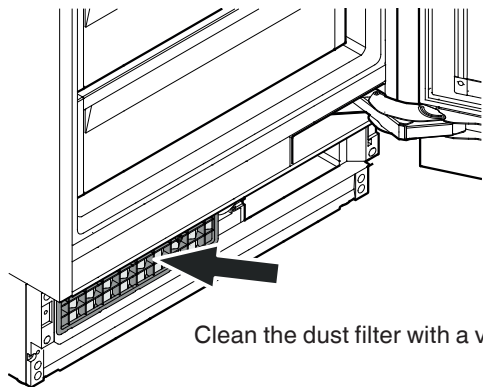
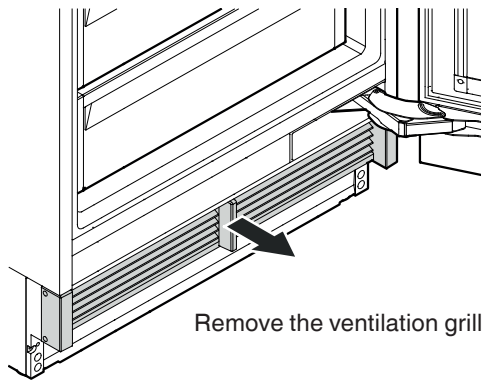

Check that there is no gap between the appliance air divider and the door air divider.

IMPORTANT

There will be a gap if the ventilation grille is fitted incorrectly.

Additional functions

BioFresh temperature adjustment
BioFresh-Plus temperature adjustment
Activating the defrost function manually
Reset to factory settings
DemoMode

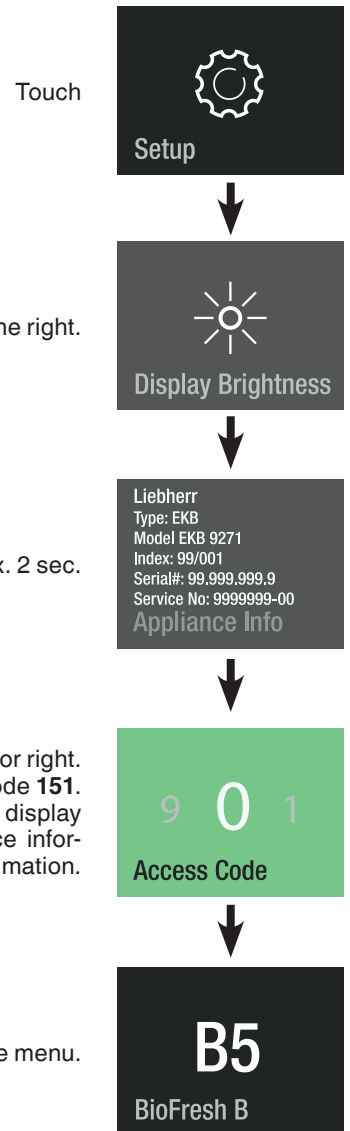

BioFresh temperature adjustment

The temperature in the upper two drawers is kept constantly at approx. 0°C. It can be adjusted to slightly warmer or colder.



For values B4 - B1, the temperature in the drawers can drop to below 0°C. Food may freeze.

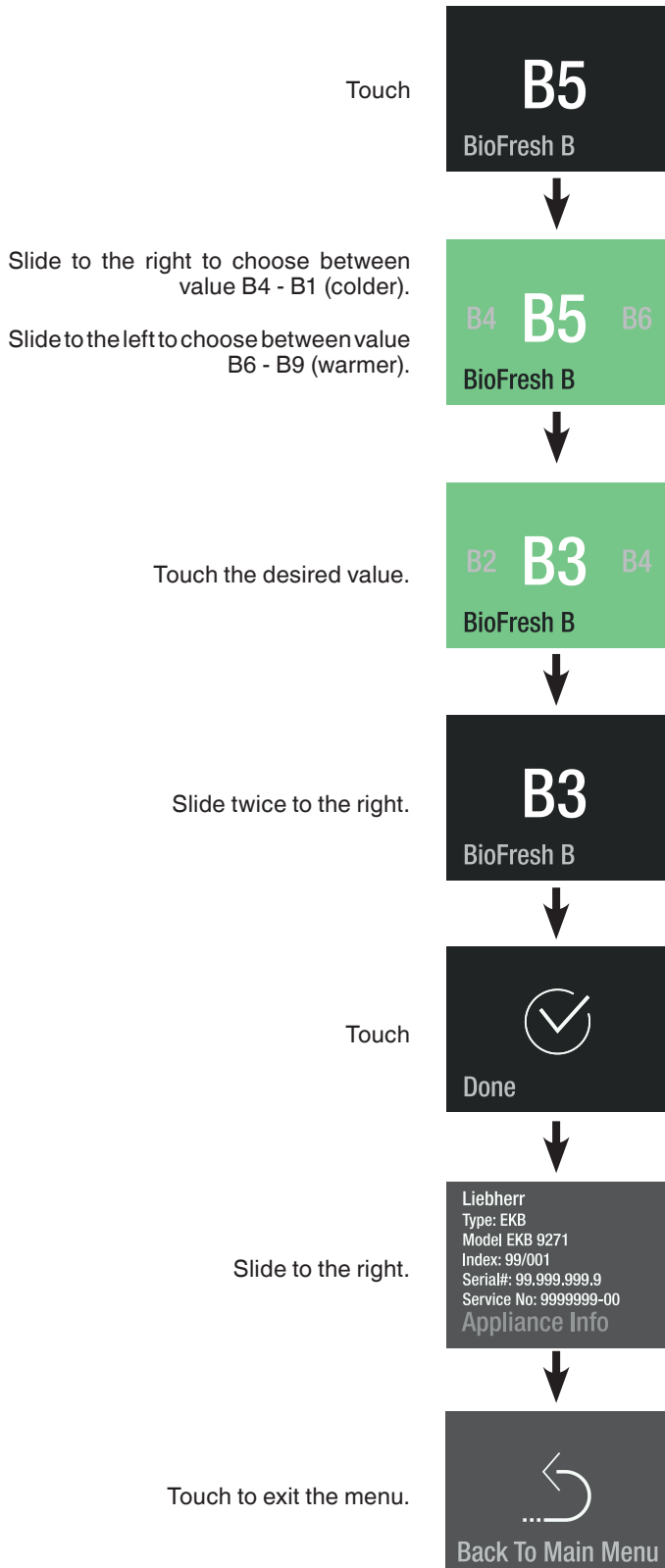

BioFresh-Plus temperature adjustment

The temperature in the bottom drawer is selectable between 0°C and -2°C. Both fixed temperature settings can be adjusted respectively to slightly warmer or colder.

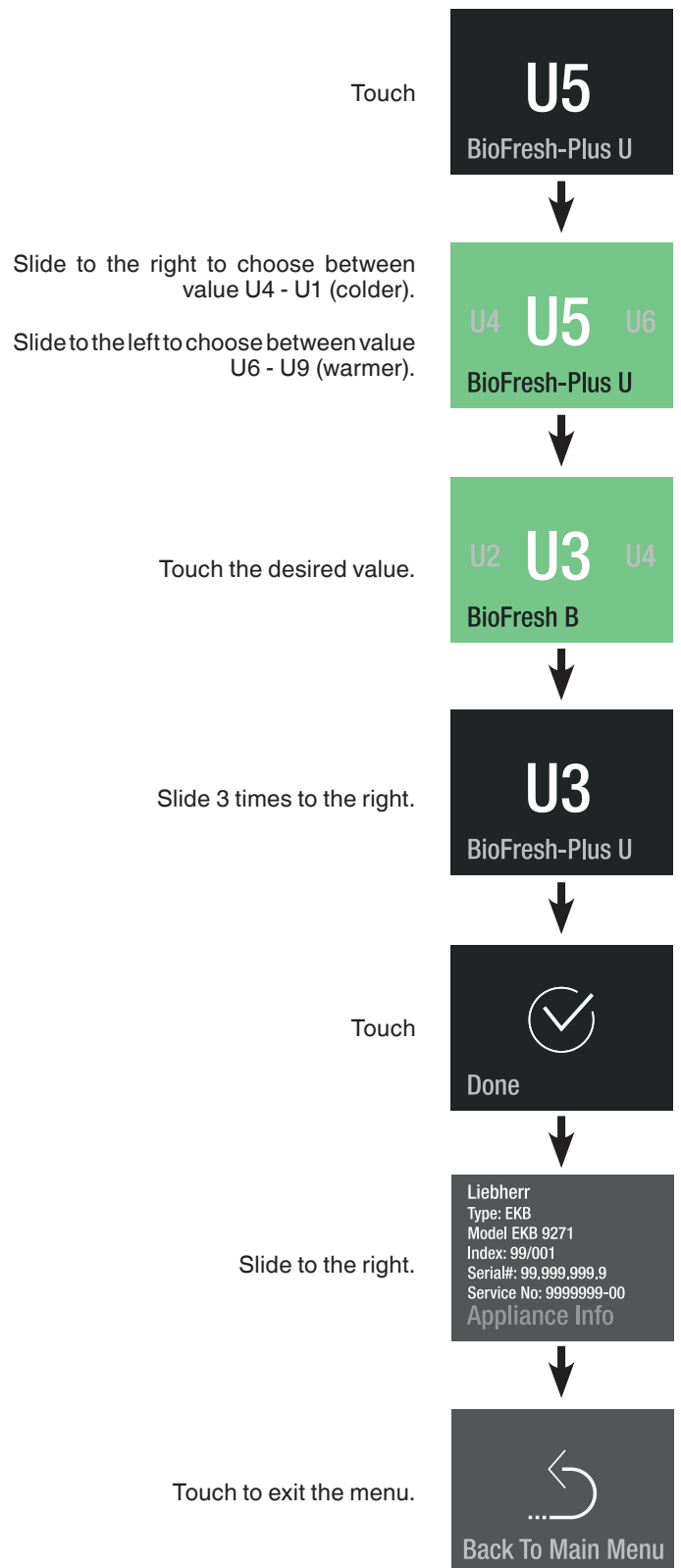

Manual defrost

The appliance defrosts automatically. The defrost function can be activated manually for service applications.

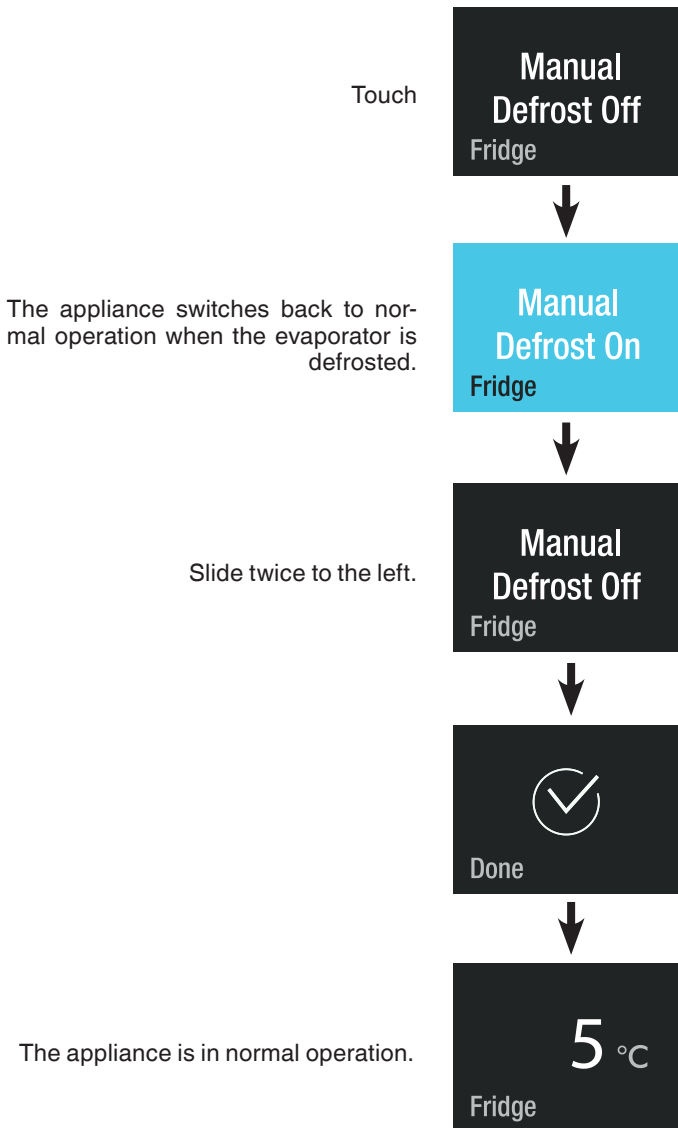

Reset

The electronic control system can be reset to factory settings using this function.

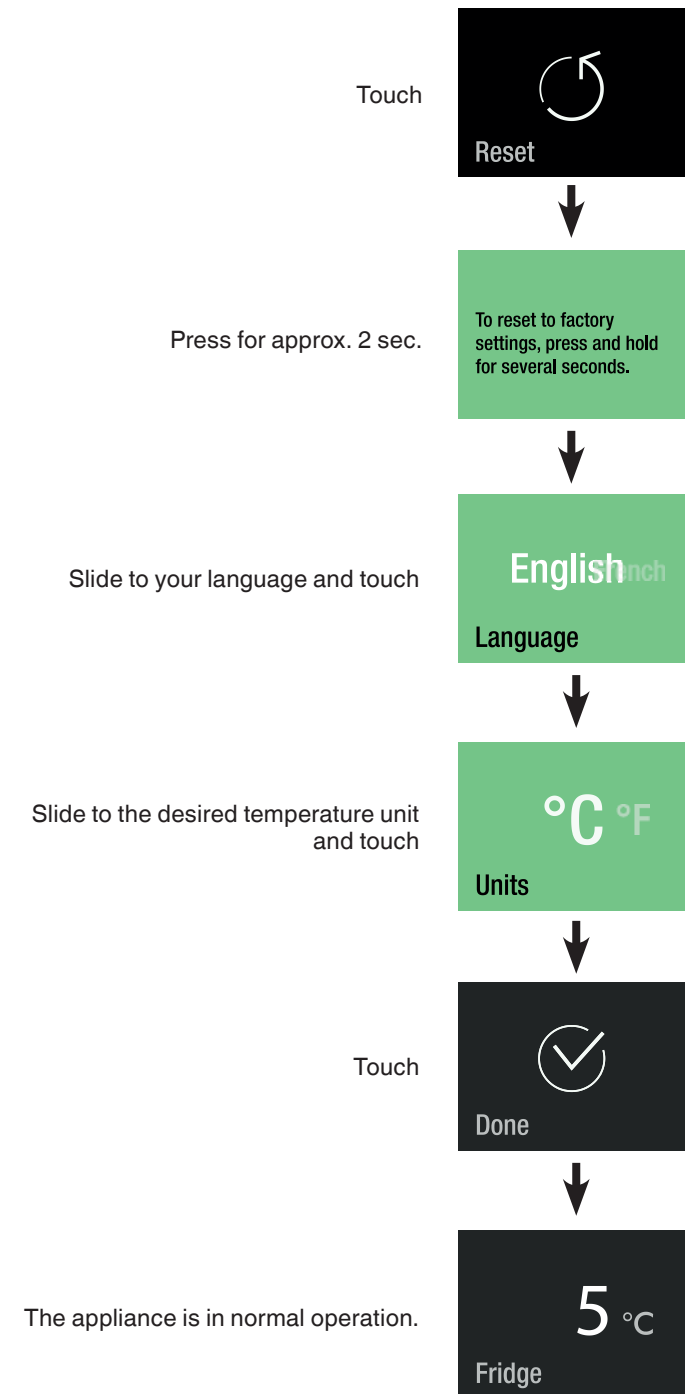

DemoMode

DemoMode can be activated for presenting the appliance at exhibitions or in salesrooms as if it were in normal operating mode.

Activating DemoMode

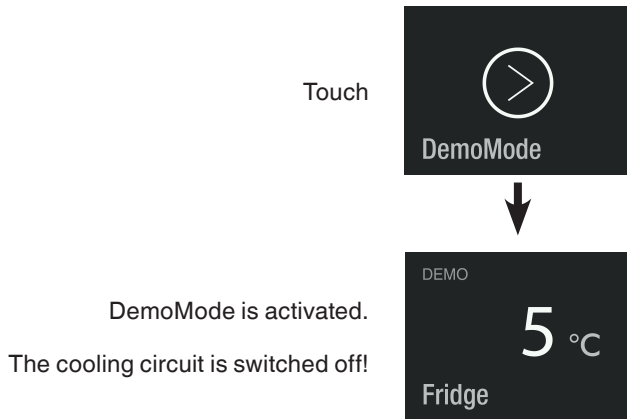

Deactivating DemoMode

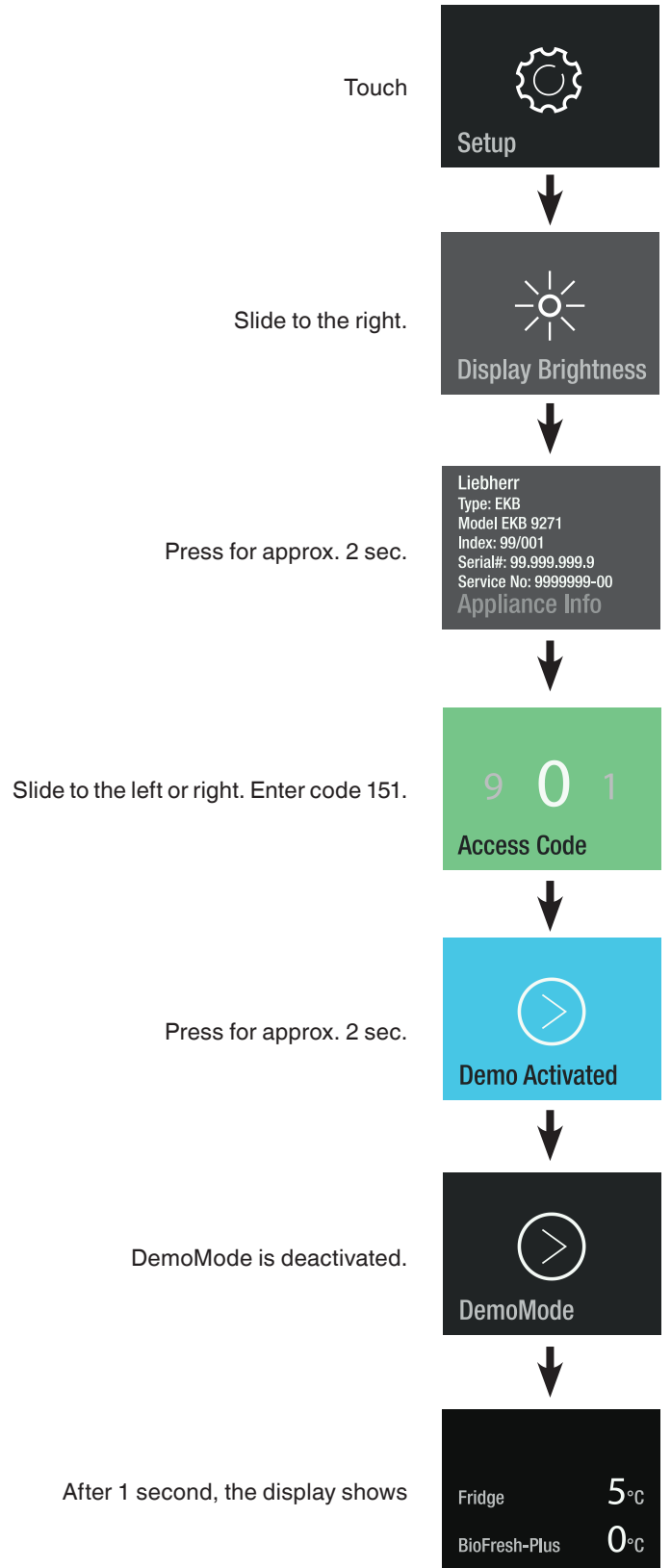

Saving energy

- Always ensure good ventilation. Do not cover ventilation openings or grille.
- Always keep fan slits clear.
- Do not place appliance in areas of direct sunlight or next to a cooker, radiator or similar object.
- The energy consumption depends on the installation conditions, e.g. the ambient temperature.
- Keep the time the appliance is open to a minimum.
- Store food logically.
- Ensure that all food is well packed and covered for storage. This will prevent frost from forming.
- First cool warm food to room temperature before storing it.
- Defrost frozen food in the refrigerator.
- Empty and switch off the refrigerator compartment for longer holiday periods.

Malfunctions

You may be able to rectify the following faults by checking the possible causes yourself:

Appliance does not function:

- Is the appliance switched on?
- Is the plug correctly fitted in the mains socket?
- Is the fuse intact?

Loud running noise:

- Is the appliance set up firmly on the floor?
- Does the appliance cause nearby items of furniture or objects to vibrate? Please note that noises caused by the refrigerant circuit cannot be avoided.

The temperature is not cold enough:

- Is the temperature setting correct (see "Setting the temperature")?
- Have excessive amounts of fresh food been placed in the appliance?
- Does the separately installed thermometer show the correct reading?
- Is the ventilation system working properly?
- Is the appliance set up too close to a heat source?

If none of the above causes apply and you cannot rectify the fault yourself, contact the nearest customer service department stating the type designation (1), service number (2) and appliance number (3) as indicated on the type plate.

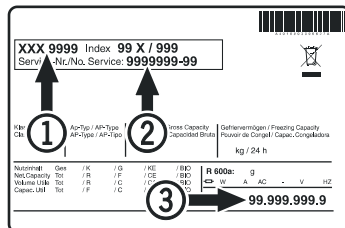

The position of the type plate is shown in the section entitled **Description of the appliance**.

Shutting your appliance down

If your appliance is to be shut down for any length of time, switch it off and disconnect the plug or switch off or unscrew the fuse. Clean the appliance and leave the door open in order to prevent unpleasant smells.

The appliance complies with the relevant safety regulations and EU Directives 2014/30/EU and 2014/35/EU.



Liebherr Hausgeräte Lienz GmbH

Dr.-Hans-Liebherr-Strasse 1

A-9900 Lienz

Österreich

www.liebherr.com

