

Operating instructions

Refrigerator

Read the operating instructions before switching on for the first time

Page 16

EN



7084 683-00

LKPv

LIEBHERR

Content

Description of the appliance.....	16	Menu 01 Setpoint = setting the temperature	21
Safety instructions and warnings	17	Menu 03 Defrosting = activating the defrost function manually	21
Range of appliance use.....	18	Menu 04 Program = resetting the temperature to the default setting.....	21
Climate rating	18	Menu 05 Alarm = list of alarms	22
Appliance dimensions	18	External alarm	22
Setting up	18	Menu 06 Settings= settings on the control electronics	23
Electrical connection.....	18	Menu 07 Light = interior light control	25
Equipment	19	Interior light LKPv 6523 / LKPv 1423	25
Back-up battery	19	Product sensor (available accessory)	25
Operating and control elements.....	20	Product sensor settings	26
Switching the appliance on and off	20	Cleaning	27
Battery charge indicator	20	Malfunctions.....	27
Set button.....	20	Shutting your appliance down.....	27
Keypad lock.....	20	Changing over door hinges LKPv 65.. / 84.....	28
Setting the language	20		
Main menu.....	21		

Description of the appliance

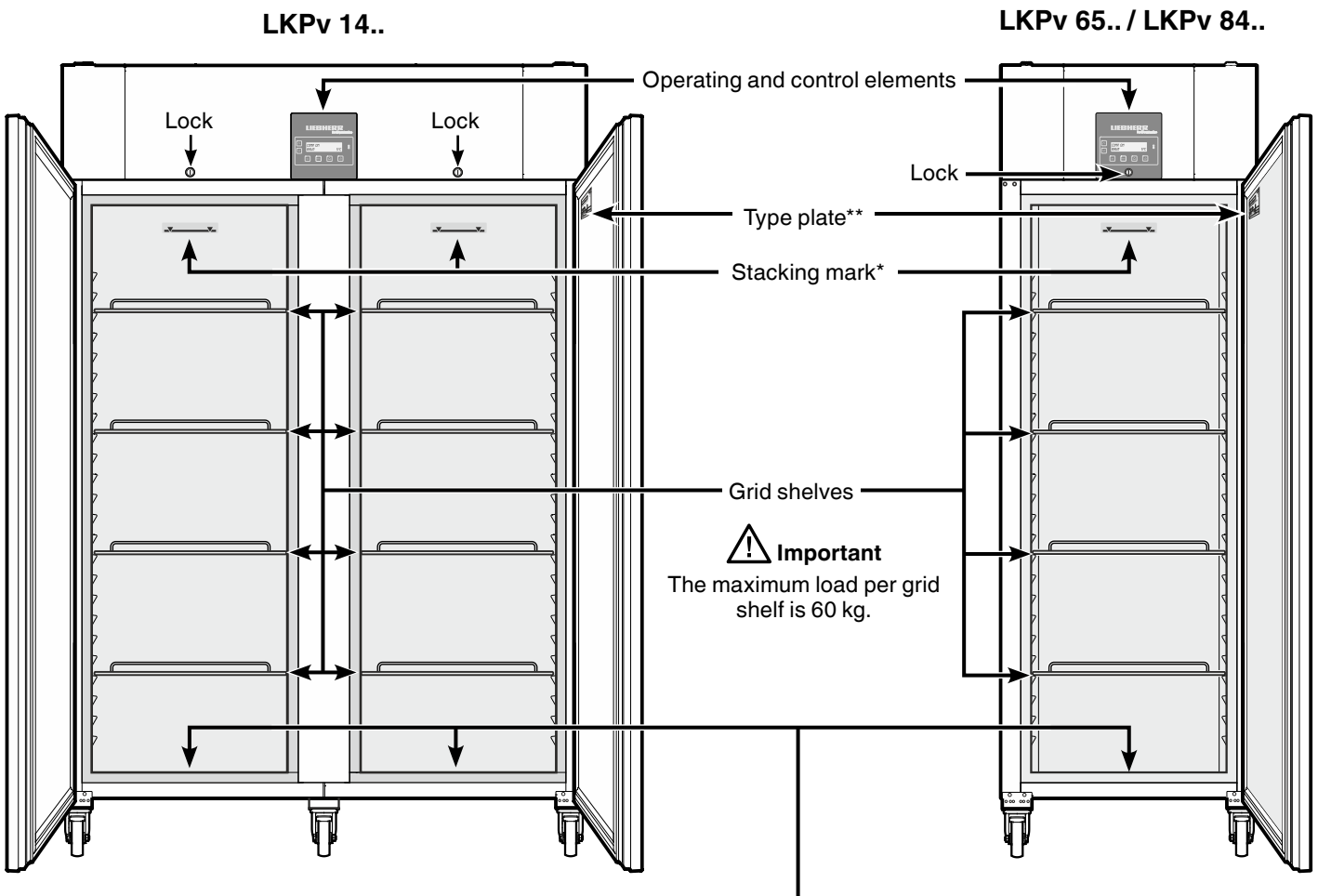

* **Stacking mark** →

Only load the top shelf up to the stacking mark.
This is important so as to ensure that the air can circulate properly and the temperature is even throughout the interior.

** LKPv 6523 / LKPv 1423

The type plate is located in the refrigerator compartment on the left-hand side.

Cleaning water drain opening

A drain hose with an R 3/4 connection can be fitted to the underside of the appliance.

The water which collects in the interior during cleaning can be drained off in this way.

An angled connector is supplied with the appliance.

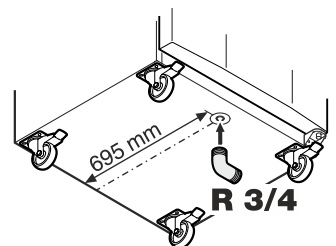

Safety instructions and warnings

- To prevent injury or damage to the unit, the appliance should be unpacked and set up by two people.
- In the event that the appliance is damaged on delivery, contact the supplier immediately before connecting to the mains.
- To guarantee safe operation, ensure that the appliance is set up and connected as described in these operating instructions.
- Disconnect the appliance from the mains if any fault occurs. Pull out the plug, switch off or remove the fuse.
- When disconnecting the appliance, pull on the plug, not on the cable.
- Any repairs and work on the appliance should only be carried out by the customer service department, as unauthorised work could prove highly dangerous for the user. The same applies to changing the mains power cable.
- Do not allow naked flames or ignition sources to enter the appliance. When transporting and cleaning the appliance, ensure that the refrigerant circuit is not damaged. In the event of damage, make sure that there are no ignition sources nearby and keep the room well ventilated.
- Do not stand on the plinth, drawers or doors or use them to support anything else.
- This appliance can be used by children of 8 years old and over, and also by persons with restricted physical, sensory or mental capacity or lack of experience and knowledge, if they are supervised or have been instructed on safe use of the appliance and understand the resulting risks. Children must not be allowed to play with the appliance. Cleaning and user maintenance must not be carried out by children without supervision.
- Avoid prolonged skin contact with cold surfaces or chilled/frozen food. This could cause pain, numbness and frostbite. In the case of prolonged skin contact, protective measures should be taken, e.g. gloves should be worn.
- Do not consume food which has been stored for too long, as it could cause food poisoning.
- Do not store explosives or sprays using combustible propellants such as butane, propane, pentane, etc. in the appliance. Electrical components might cause leaking gas to ignite. You may identify such sprays by the printed contents or a flame symbol.
- Do not use electrical appliances inside the appliance.
- If you have a lockable appliance, do not keep the key near the appliance or within reach of children.
- The appliance is designed for use in enclosed areas. Do not operate the appliance outdoors or in areas where it is exposed to splash water or damp conditions.
- Do not install the appliance in the immediate vicinity of an air-conditioning unit. The appliance should also not be operated under a wall-mounted air-conditioning unit.
- The appliance is **not** suitable for storing drugs pursuant to DIN 58345.
- The appliance is **not** suitable for storing blood bottles pursuant to DIN 58371.
- In special fields of application which are subject to their own standard, the user is responsible for complying with this standard.

LKPv 6523 / LKPv 1423

- When transporting or operating the appliance at an altitude of more than 1500 m above sea level, the glass pane in the door can break due to the reduction in air pressure. Broken fragments are sharp-edged and can cause serious injury.
- The LED light strip illuminates the interior of the appliance. It is not suitable for lighting a room.

Noise emissions from the appliance

The noise level while the appliance is operating is below 70 dB(A) (relative noise level 1 pW).

Range of appliance use

The appliance is suitable for storing and cooling laboratory preparations at temperatures of between

-2°C and +16°C (LKPv 6520, 1420),
0°C and +16°C (LKPv 6523, 1423).

The appliance is **not** suitable for use in explosion-hazard areas.

For the storage of valuable or temperature-sensitive substances or products the use of an independent, constantly monitoring alarm system is necessary.

This alarm system must be designed so that each alarm status is detected immediately by an authorised person who can then take appropriate action.

Position the temperature sensor for this system in the upper part of the interior container.

Climate rating

The climate rating indicates the room temperature at which the appliance may be operated in order to achieve full refrigeration performance.

The climate rating is indicated on the type plate.

The position of the type plate is shown in the section entitled **Description of the appliance**.

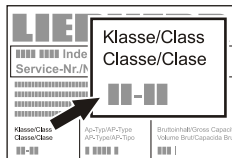

Climate rating	Room temperature
4 (SN)	+10°C to +32°C
4 (N)	+16°C to +32°C
4+ (ST)	+16°C to +38°C
4+ (SN-ST)	+10°C to +38°C
5 (T)	+16°C to +43°C
5 (SN-T)	+10°C to +43°C

Do not operate the appliance outside the specified room temperature range.

Appliance dimensions

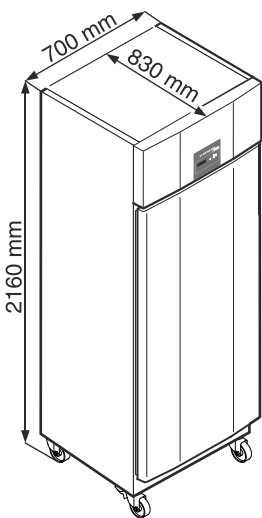

LKPv 65..

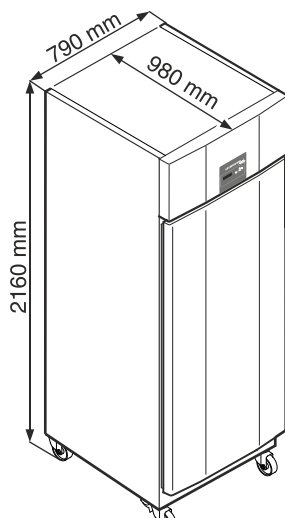

LKPv 84..

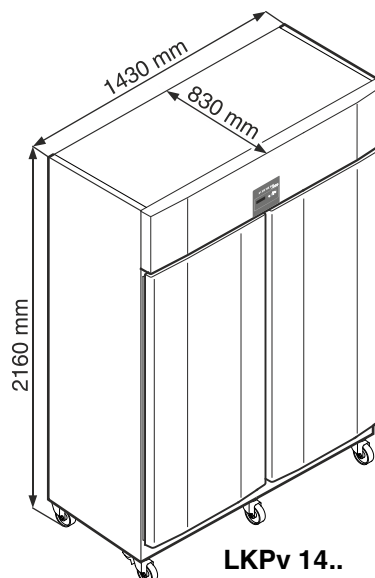

LKPv 14..

Setting up

- Avoid positioning the appliance in direct sunlight or near cookers, radiators and similar sources of heat.
- The floor on which the appliance stands should be horizontal and level.
- Standard EN 378 specifies that the room in which you install your appliance must have a volume of 1 m³ per 8 g of R 290a refrigerant used in the appliance, so as to avoid the formation of inflammable gas/air mixtures in the room where the appliance is located in the event of a leak in the refrigerant circuit. The quantity of refrigerant used in your appliance is indicated on the type plate on the inside of the appliance.
- There must be a gap of at least 30 cm between the upper edge of the appliance and the ceiling.

Do not cover ventilation openings or grille. →

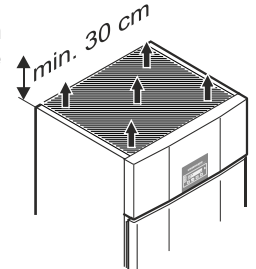

Electrical connection

Only operate the appliance with **alternating current (AC)**.

The permissible voltage and frequency are indicated on the type plate. The position of the type plate is shown in the section entitled **Description of the appliance**.

The socket must be properly earthed and protected by a fuse.

The tripping current of the fuse must be between 10 A and 16 A.

The socket must not be situated behind the appliance and must be easily accessible.

Do not connect the appliance using an extension cable or extension socket.

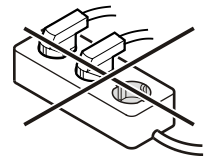

Do not use stand-alone inverters (conversion of direct current to alternating/three-phase current) or energy-saving plugs. Risk of damage to the electronic control system!

Equipment

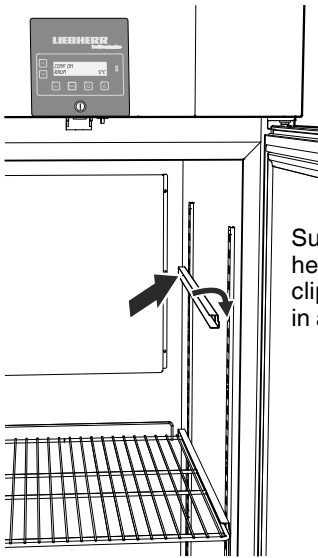

Suspend the rails at the desired height, by inserting into the rear clip-in strip first and then clipping in at the front.

LK Pv 1490 equipment

Fit the supplied shelf rails to the right and left of the vertical bar.

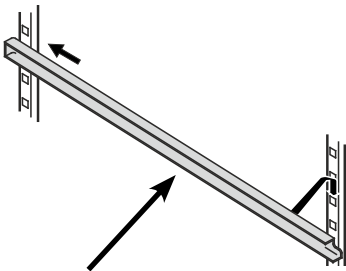

Suspend the rails at the desired height, by inserting into the rear clip-in strip first and then clipping in at the front.

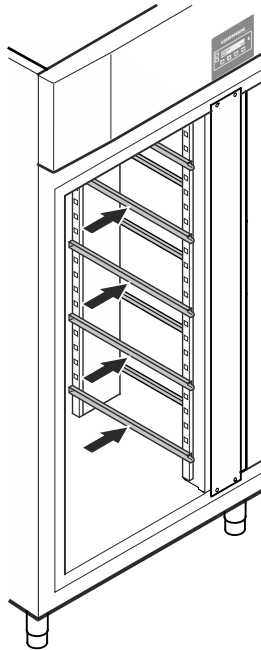

Intermediate shelves

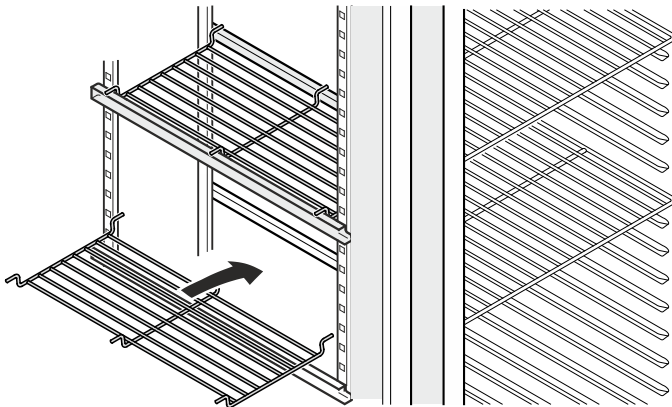

Place the supplied intermediate shelves onto the shelf rails.

Note

The maximum load per intermediate shelf is 20 kg.

Safety lock

The lock is equipped with a safety mechanism.

Locking the appliance

- Insert the key as shown by arrow 1.
- Turn the key 180° (2).

To unlock the appliance, the same procedure must be repeated in the same order.

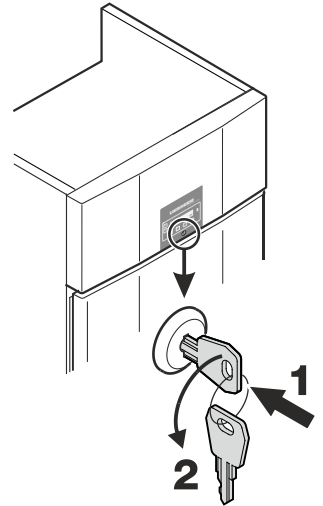

Back-up battery

Before the appliance is switched on, the battery which is fitted in the compressor compartment must be connected.

This battery ensures that alarms are always reported, even in the event of a power failure.

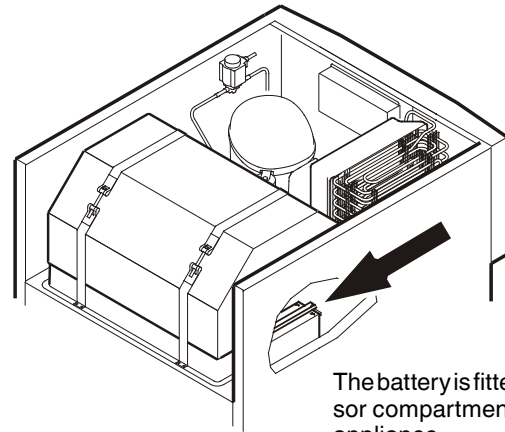

The battery is fitted in the compressor compartment at the top of the appliance.

Important!

The appliance must not be connected to the electrical power supply yet.

Remove cover.

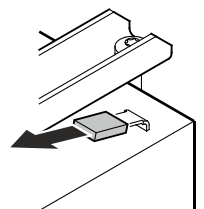

Plug the connector onto the positive pole on the battery.

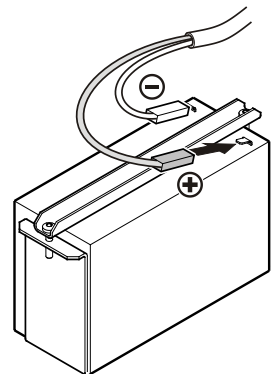

Disposal instructions for batteries

The battery must be removed when you wish to dispose of the appliance and sent for separate waste treatment for batteries.

Do not damage or short circuit the battery.

Operating and control elements

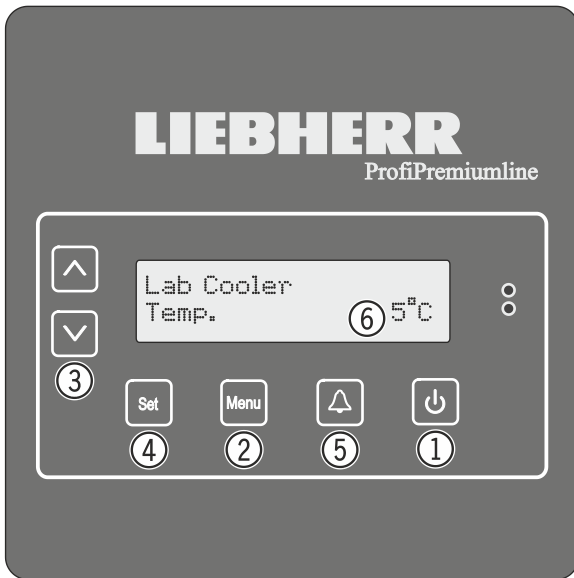

- ① **ON/OFF** button (to switch the appliance on and off)
- ② **Menu** button (to activate the main menu)
- ③ Selection buttons
- ④ **Set** button (Enter)
- ⑤ **Audible warning** on/off button
- ⑥ Display (above indication in display = standard indication)

Note: the **Menu** button can be used to cancel any unintentional actions and return to the standard indication without changing the value.

Switching the appliance on and off

You are advised to clean the appliance before switching it on for the first time (see "Cleaning").

- Connect the appliance to the mains - the display reads **OFF**.

Switching the appliance on

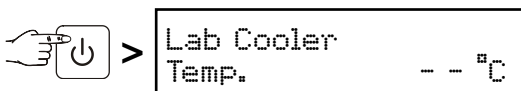

Switching the appliance off

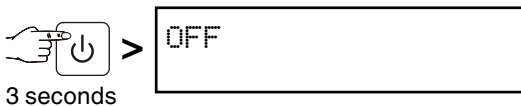

Battery charge indicator

If the symbol  appears in the display, it is necessary to check whether the battery has been connected. See section entitled **Back-up battery**.

In normal operation, the symbol also appears while the battery is being recharged.



Set button

If the **Set** button is pressed in standard display mode, the date and time appear in the display.

DD/MM/YY
hh:mm:ss

Press the **Set** button again to return to the standard indication.

This is not automatic.

Keypad lock

The keypad lock ensures that no unintentional changes are made to the electronic control system.

Activating the keypad lock

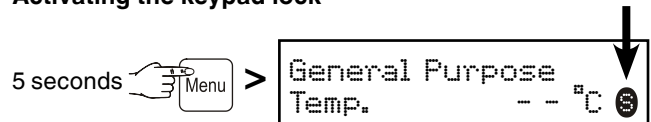

 appears in the display.

To deactivate, press again for 5 seconds.

Setting the language

Note: The preset language is **English**.

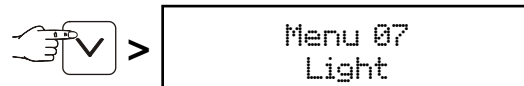
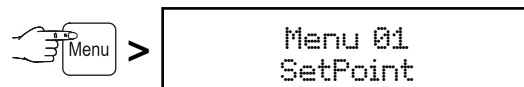

If this is the language which should remain, the following procedure is not necessary.

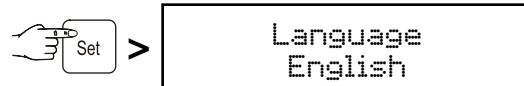
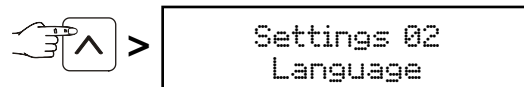
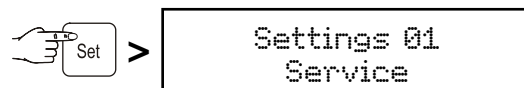
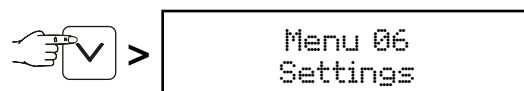

Note:

Menu 07 only appears on appliances LK Pv 6523 and LK Pv 1423.



Use buttons  and  to select the desired language.

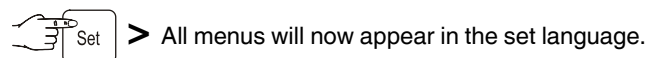



Press the **Menu** button to return to the standard indication.

If no button is pressed within 60 seconds, the electronic control system switches back automatically.

Main menu

Press the  button.

Use buttons  and  to select one of the menu items.

Menu 01

Setpoint = setting the temperature

Menu 03

Defrosting = activating the defrost function manually

Menu 04

Program = resetting the temperature to the default setting

Menu 05

Alarm = list of alarms

Menu 06

Settings = settings on the control electronics

Menu 07 (on LKPV 6523 and LKPV 1423 only)



Light = interior light control

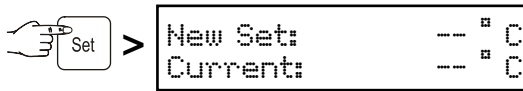
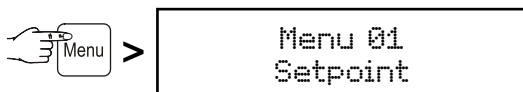

Menu 01

Setpoint = **setting the temperature**



The current temperature is then shown at the bottom of the display and the required temperature is shown at the top.

Use button  to reduce the temperature = colder. Use button  to increase the temperature = warmer.

Press the  button to accept the new setting or the  button to cancel the procedure without saving.

Menu 03



Defrosting = **activating the defrost function manually**

The appliance defrosts automatically.

If the door has been left slightly open for a long time, a layer of ice may form in the interior and on the cooling plate.

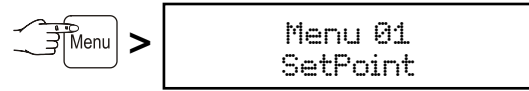
The defrost function can then be activated manually.





Press button  to start defrosting or press the  button to cancel the procedure.

Menu 04

Programs = **resetting the temperature to the default setting**

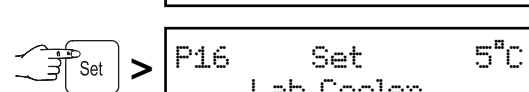
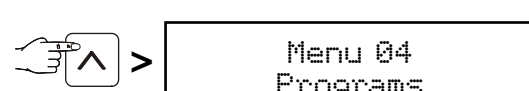
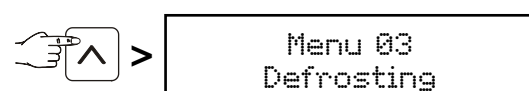
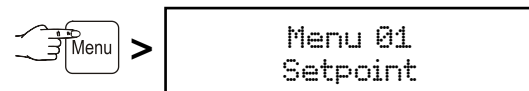
The temperature may be returned to the value set when the appliance was delivered.



Press the  button to accept the new setting or the  button to cancel the procedure without saving.

Menu 05 Alarm = list of alarms

The alarm events are saved and can be called up if required.

Thanks to an integrated battery, the electronic control system is supplied with power, even in the event of a power failure, and the alarm status is indicated immediately.

The audible warning signal sounds every time an alarm event occurs.

The audible warning signal can be cancelled by pressing button



The following alarm can be rectified immediately:

```
Door Open
Temp.      -- °C
```

When the door is open, the above indication and the standard indication flash alternately. After 60 seconds, the audible warning signal sounds.

Cancel the audible warning signal by pressing button . Close the appliance door.

The following alarm events require the stored items to be checked:

1.

```
UPS activated
Temp.      -- °C
```

The above indication and the standard indication flash alternately.

The audible warning signal sounds.

This indication is displayed after a power failure.

Call up the length of the power failure and the maximum temperature reached inside the appliance. See chapter "Calling up the saved alarm events".

2.

```
High Temp Room
Temp.      -- °C ↑
```

```
Low Temp Room
Temp.      -- °C ↓
```

The above indication and the standard indication flash alternately.

The audible warning signal sounds.

This can be caused by:

- the appliance door being left open for a long time, allowing warm ambient air to enter;
- a long power failure;
- a fault in the appliance.

If a large quantity of warm items is placed in the appliance at once, this alarm may occur. This does not mean that there is an error.

Call up the length of the temperature rise and the maximum temperature reached inside the appliance. See chapter "Calling up the saved alarm events".

In both cases, the items must be checked and it must be decided if they can still be used.

All other alarms which occur must be rectified by a customer service technician.

Calling up the saved alarm events

>

```
Menu 01
SetPoint
```

>

```
Menu 06
Settings
```

>

```
Menu 05
Alarm
```

> The last alarm which occurred is shown in the display.

30 alarm events are saved.

The highest figure (A _ _) is the last alarm which occurred.

Select a previous alarm event by pressing the buttons and .

>

```
A01      Door Open
S hh:mm   DD/MM/YY
```

Start of the alarm event with time and date.

>

```
A01      Door Open
E hh:mm   DD/MM/YY
```

End of the alarm event with time and date.

>

```
A01      Door Open
Temp Max  -- °C
```

Highest temperature reached inside the appliance.

Return to the standard indication by pressing the button.

Note

After this query, the alarm display will be deleted automatically.

External alarm

The appliance can be connected to an external alarm device.

A floating alarm contact and an RS485 interface are available.

A refitting kit for serial data evaluation via the RS485 interface is available from your dealer or our customer service department.

The appliance may only be connected to an external alarm device by trained personnel!

Menu 06 Settings

= settings on the control electronics

Settings 01 Service

These settings can only be carried out by the customer service department.

Settings 02 Language

Setting the display language. See paragraph "**Setting the language**".

Settings 03 Clock Setting

Setting the time and date.

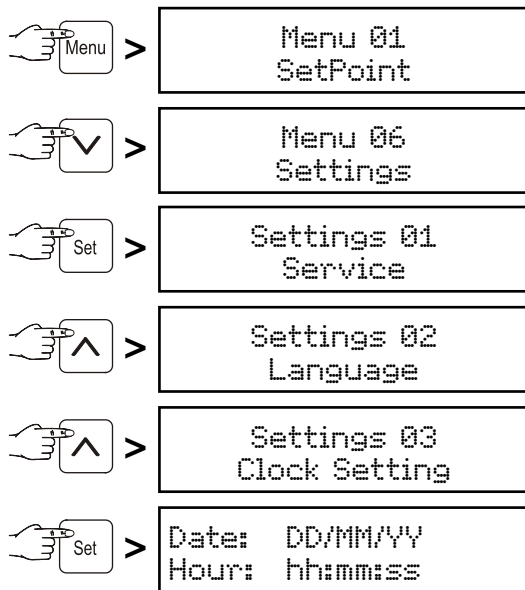

The value to be changed flashes and can be changed by pressing the buttons and .

Save by pressing the button.

Return to the standard indication by pressing the button.

The conversion from summer to winter time is **not** automatic.

Settings 04 Inputs/Outputs

These settings can only be carried out by the customer service department.

Settings 05 Communication

This menu item is described in the documentation on the accessories set "Serial data evaluation".

Settings 06 Display

Setting for permanent display light.

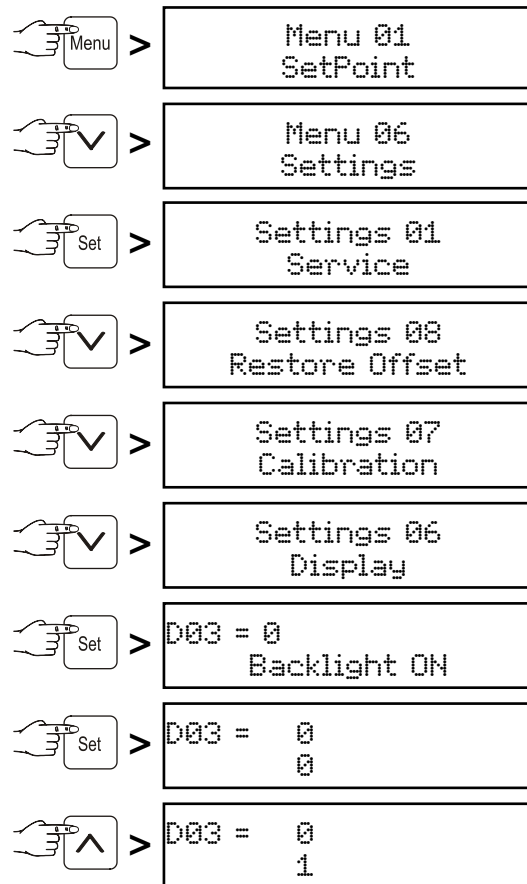

Save by pressing the button.

Return to the standard indication by pressing the button.

The display is now permanently lit.

Menu 06 Settings

Settings 07

Calibration

Adjustment of the displayed temperature to the actual interior temperature.

Tolerances of temperature sensors can be offset with this function.

Adjustment is possible in three temperature ranges.

CAL1 = lower temperature range (approx. -2°C)

CAL2 = middle temperature range (approx. 5°C)

CAL3 = upper temperature range (approx. 16°C)

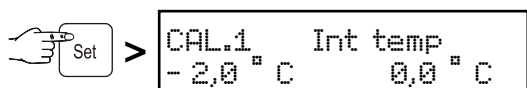
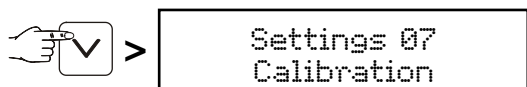
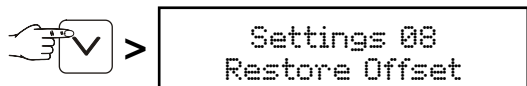
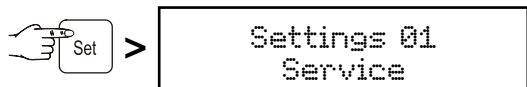
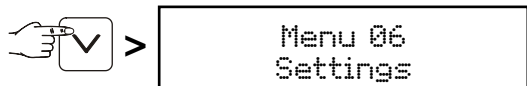
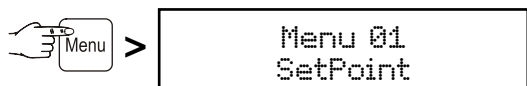

↑ °C flashes



The temperature range display flashes and can be changed using the buttons or (e.g. -1°C).

Save by pressing the button.

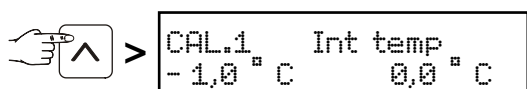

°C flashes ↑



The temperature correction value flashes and can be changed using the buttons or .

Save by pressing the button.

Use button to proceed to CAL.2 and further to CAL.3 and adjust the settings in the same way as for CAL.1.

Return to the standard indication by pressing the button.

Settings 08

Restore Offset

Setting the temperature correction values to 0.

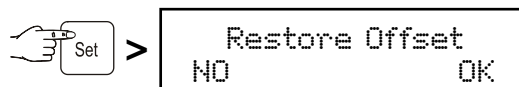
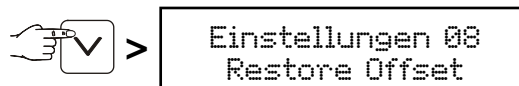
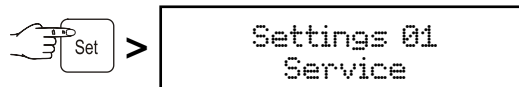
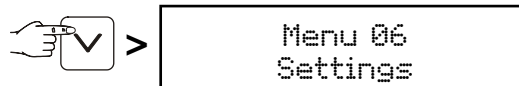
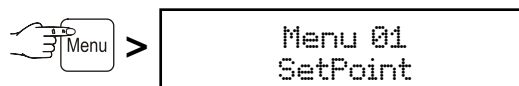

Press button to set the temperature correction values for CAL1, CAL2 and CAL3, respectively, to 0 or cancel the procedure without any changes by pressing the button.

Return to the standard indication by pressing the button.

Menu 07 Light = interior light control

Note

This function is only active on appliances LKPV 6523 and LKPV 1423.

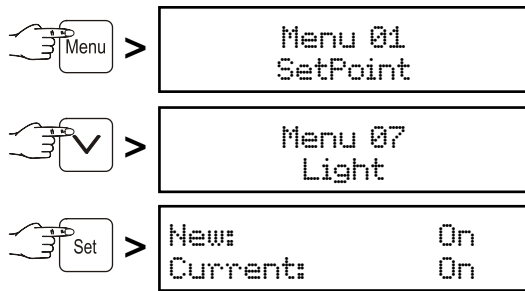

Use buttons and to select the desired setting.

On = interior light permanently lit.

Door = interior light is switched on when the door is opened and is switched off when the door is closed.

Off = interior light switched off.

Press the button to accept the new setting or the button to cancel the procedure without saving.

Interior light LKPV 6523 / LKPV 1423

The interior light is fitted on the inside at the top.

The light intensity of the LED light corresponds to laser class 1/1M.

! Important

The light cover may only be removed by customer service staff.

If the cover is removed, do not look directly at the light through optical lenses from close distance.

This can damage your eyes.

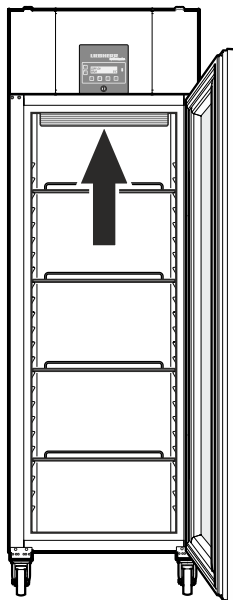

Product sensor (available accessory)

The temperature may be measured or recorded at any point in the interior using the product sensor.

Remove the plug!

1. Feed the sensor through the opening in the compressor compartment and position inside the appliance.

Seal the opening with sealant.

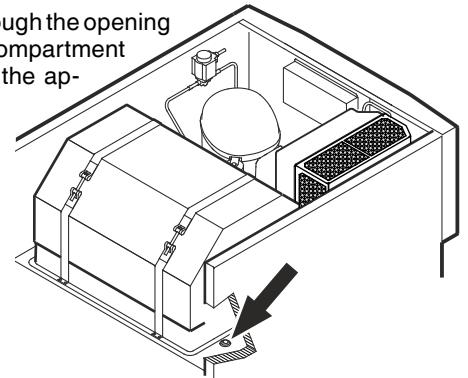

2. Undo the screw on the underside of the front panel. Tilt the front panel upwards.

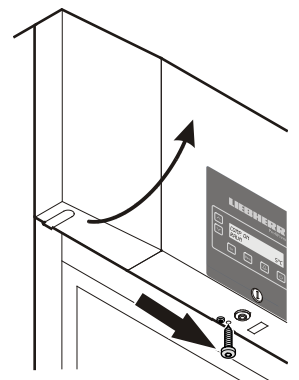

3. Plug in the product sensor

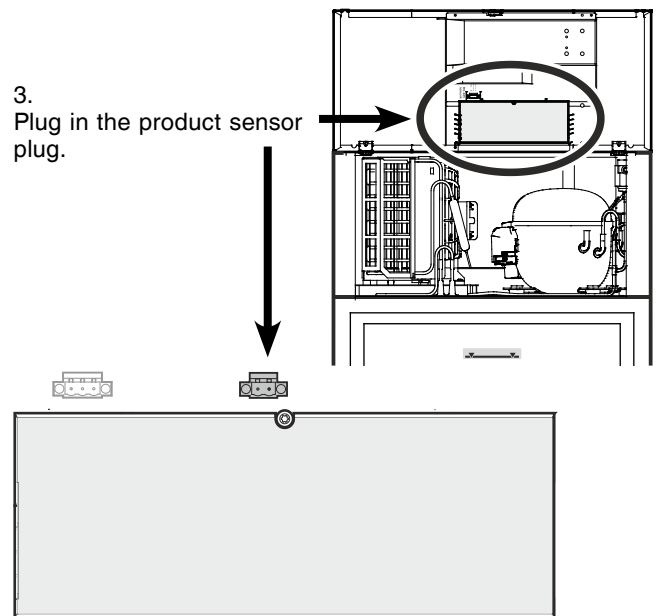

4. Close the front panel and fix with the screw.

Product sensor settings

- Connect the appliance to the mains - the display reads OFF.

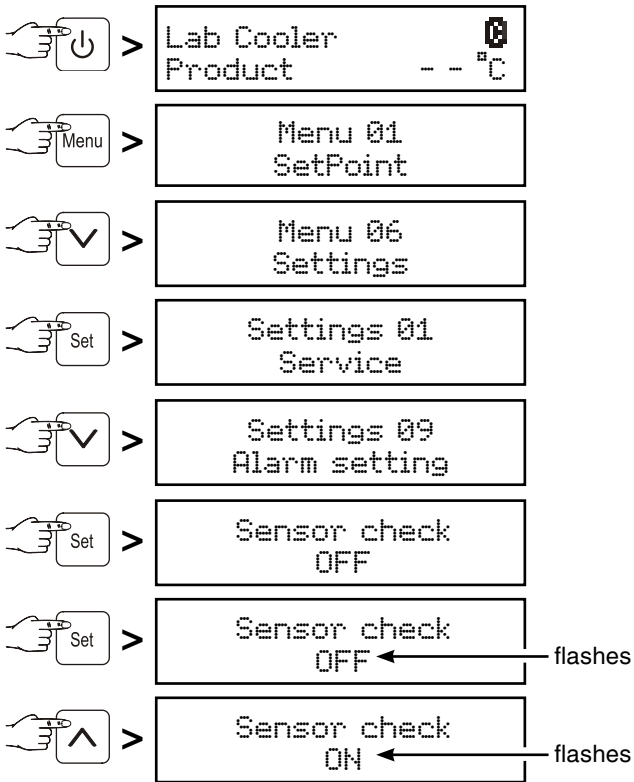

Save by pressing the **Set** button.

The sensor is now monitored by the electronic control system. In the event of a sensor error, an alarm will be signalled.

Adjusting the alarm limits

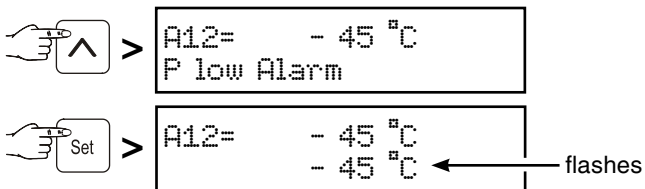

Use buttons **↓** and **↑** to select the desired setting.

Save by pressing the **Set** button.

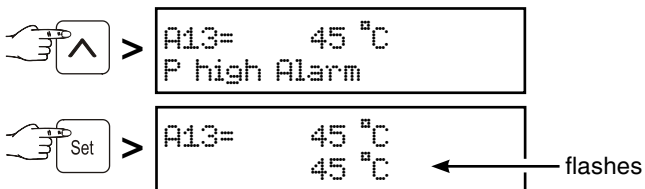

Use buttons **↓** and **↑** to select the desired setting.

Save by pressing the **Set** button.

If an alarm delay needs to be set, carry out the steps in the next section or return to the default display by pressing the **Menu** button.

Adjusting the alarm delay

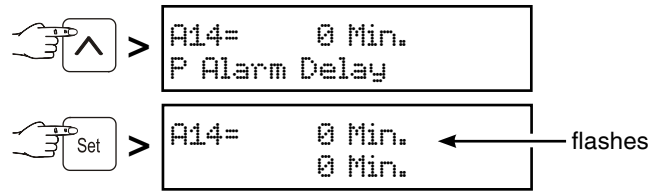

Use buttons **↓** and **↑** to select the desired setting.

Save by pressing the **Set** button.

Return to the standard indication by pressing the **Menu** button.

Note

When in standard display mode, it is possible to switch between product sensor, standard temperature sensor, both sensors and date/time using the **Set** button.

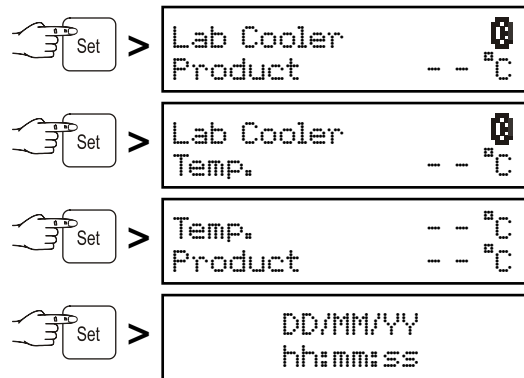

Cleaning

Clean the appliance at least twice per year.

Before cleaning always switch off the appliance. Pull out the mains plug or switch off or unscrew the fuse.

- Empty the appliance and store the food in a cool place.
- Clean the inside and equipment with lukewarm water and a little detergent. Do not use abrasive or acid cleaners or chemical solvents.

Do not use steam cleaners because of the risk of injury and damage.

- Ensure that no cleaning water penetrates into the electrical components or ventilation grille.
- Dry all parts well with a cloth.
- Use a commercially available stainless-steel cleaning agent for stainless-steel appliances.

Do not use abrasive sponges or scourers, do not use concentrated cleaning agents and never use cleaning agents containing sand, chloride or acid or chemical solvents, as these would damage the surfaces and could cause corrosion.

Cleaning the dust filter

Clean the dust filter at least twice per year!

Remove the plug!

1. Remove the dust filter by lifting upwards.
2. Clean the dust filter with water and detergent.
3. Reinstall the dust filter.

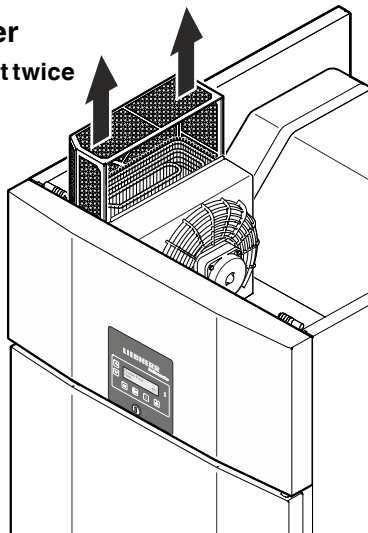

Malfunctions

You may be able to rectify the following faults by checking the possible causes yourself:

• Appliance does not function:

- Is the appliance switched on?
- Is the plug correctly fitted in the mains socket?
- Is the fuse intact?

• The temperature is not low enough:

- Is the temperature setting correct (see "Setting the temperature")?
- Does the separately installed thermometer show the correct reading?
- Is the ventilation system working properly?
- Is the appliance set up too close to a heat source?

If none of the above causes apply and you cannot rectify the fault yourself, contact the nearest customer service department stating the type designation ①, service number ② and appliance number ③ as indicated on the type plate.

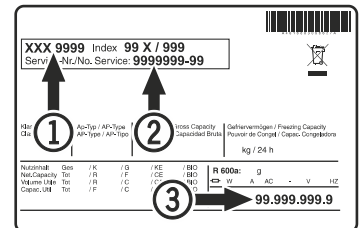

The position of the type plate is shown in the section entitled **Description of the appliance**.

Shutting your appliance down

If your appliance is to be shut down for any length of time, switch it off and disconnect the plug or switch off or unscrew the fuse.

Clean the appliance and leave the door open in order to prevent unpleasant smells.

The appliance complies with the relevant safety regulations and EC Directives 2004/108/EC and 2006/95/EC.

Changing over door hinges LKPV 65.. / 84..

Door hinges should only be changed by a trained expert.
Changing the door hinges must be done by two people.

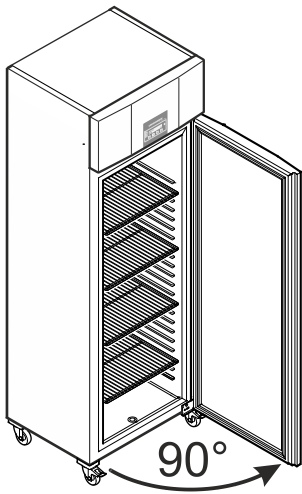

1. Open door by about 90°.

Important note

The door must be opened 90° before the lower hinge bracket is removed.

This will hold the self-closing mechanism that is integrated into the door in the required position for installation.

⚠ WARNING!

If the door is removed and reinstalled in the closed position, this will lead to destruction of the self-closing mechanism on the first opening of the door.

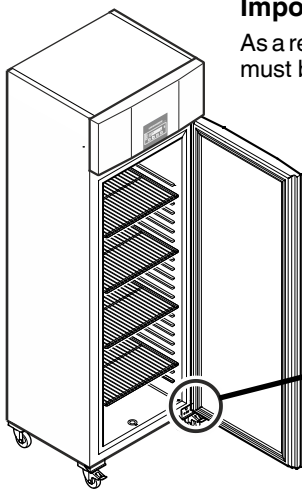

Important

As a result of its heavy weight, the door must be held secure by one person.

2. Remove hinge bracket.
Pull the door out at the bottom and lift off.

3. Remove bearing ring from upper door mounting.

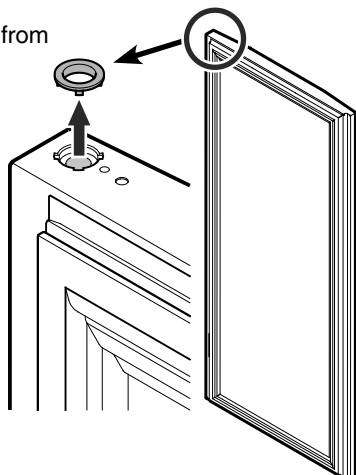

4. Remove the hinge components from the hinge bracket.

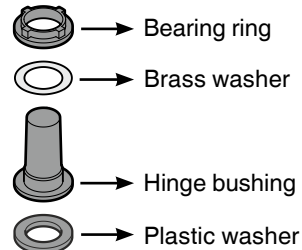

Note on point 4

The hinge bushing with brass washer and bearing ring may stick in the door mounting when you pull out the hinge bracket and, in this case, must be removed from it.

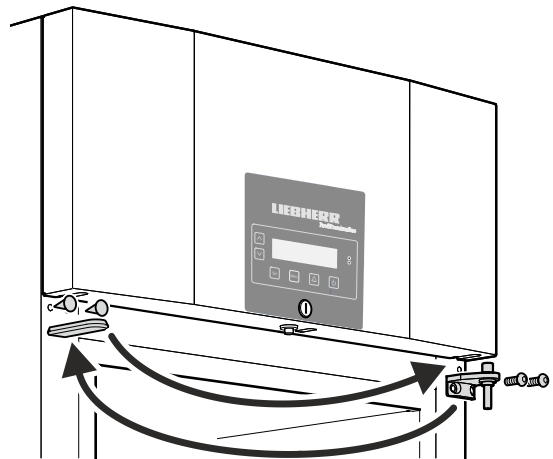
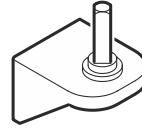

5. Transfer the upper hinge bracket and covers to the opposite side.

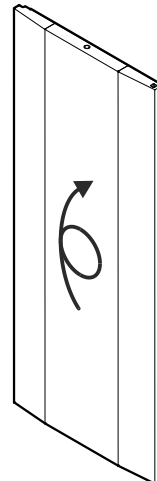

6. Turn the door by 180°.

7. Insert the bearing ring and hinge bushing in the upper door mounting.

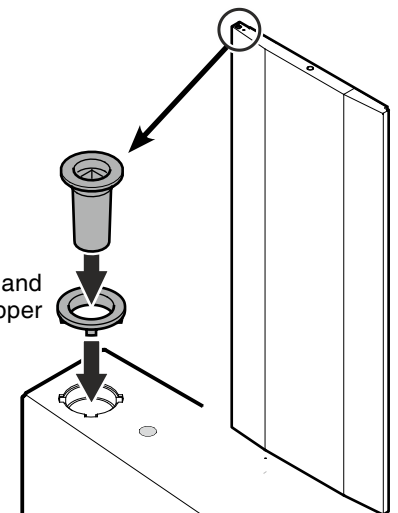

8. Unscrew base mounting bracket and attach on the other side.

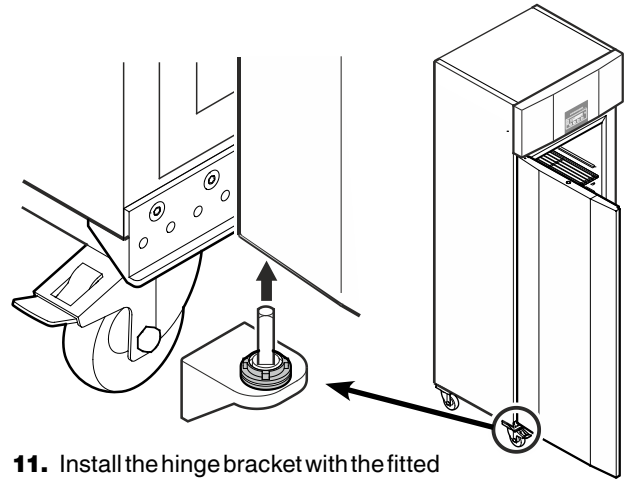
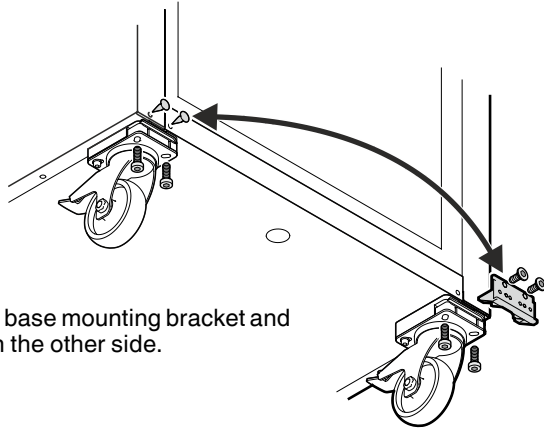

11. Install the hinge bracket with the fitted hinge components in the lower door mounting.

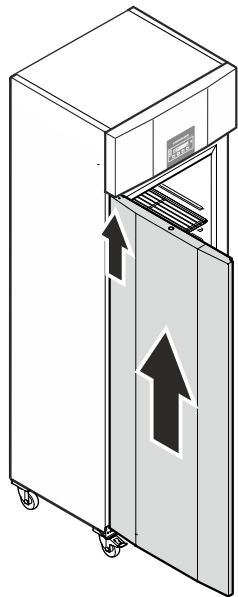

9. Keeping door open at 90°, suspend in top square pin.

WARNING!

It is essential that the door is open at an angle of 90° during installation.

If the door is installed in the closed position, this will lead to destruction of the self-closing mechanism on the first opening and closing of the door.

Important

As a result of its heavy weight, the door must be held secure by one person.

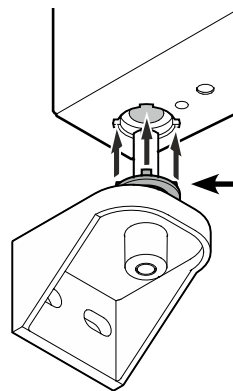

Note on point 11

The tabs on the bearing ring must fit into the recesses of the door mounting during installation.

If necessary, gently rotate the upper ring.

10. Fit the hinge components on the hinge bracket.

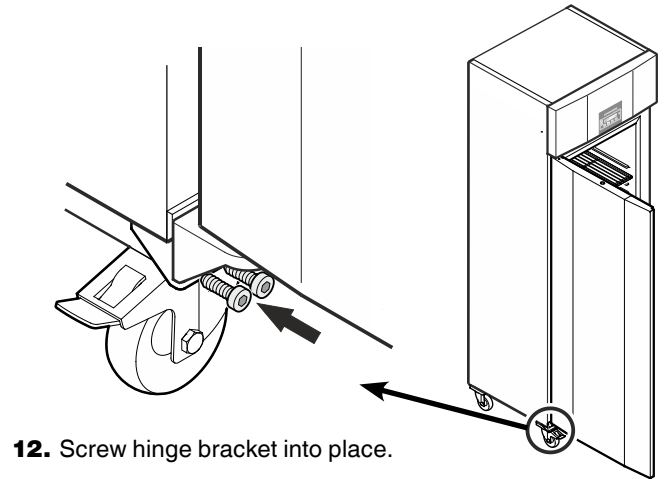
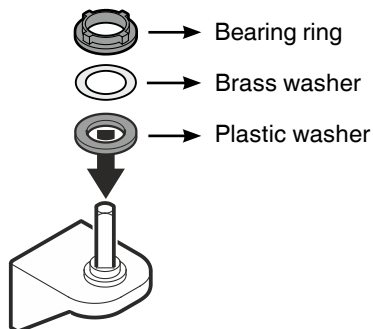

12. Screw hinge bracket into place.